



*NETWORK INDEPENDENT PROTOCOLS FOR
INTERACTIVE SERVICES*

DVB DOCUMENT A021
February 1997

Reproduction of the document in whole or in part without prior permission of the DVB Project Office is forbidden.

Contents

1 Scope	3
2 Normative references	3
3 Abbreviations.....	4
4 Protocol Stack and System models	6
4.1 Protocol Stack model.....	6
4.2 System model	7
4.3 Logical model.....	7
5 Protocol stacks	10
5.1 S1 - Broadcast or Narrowcast Content - audio, video, data.....	10
5.2 S2 - ACD/ACD and DDC between Server and STB.....	10
5.3 S3 - Session control signalling.....	11
5.4 S4 - Connection control signalling	13
5.5 S5 - Capability Transfer and Network Management	13
6 PPP data link setup	14
6.1 PPP configuration for IP transmission	14
7 Network congestion contro.....	14
8 Session control in DVB interactive services.....	14
8.1 Introduction.....	14
8.2 Session establishment.....	14
8.3 Session release	16
8.4 Status inquiry	17
8.5 Connection reset.....	17
Annex A (informative): Bibliography.....	18

1 Scope

This ETS covers the core Digital Video Broadcasting (DVB) requirements to enable interactive services supporting broadcasting to the home with narrowband return channels (see annex A: Bibliography - "DVB commercial requirements").

The system defined in this ETS provides a generic solution for a variety of future interactive services, through the adoption of DSM-CC User-to-User, Download and Object Carousel protocols, as specified in MPEG2 [2].

The interactive services are provided on systems consisting of a high bitrate downstream channel (up to the maximum bitrate of the Broadcast channel) from the Service Providers to Service consumers and low bitrate interaction channels (up to 150 kbit/s). The Broadcast Service Provider and the Interactive Service Provider need not operate from the same location.

The services are primarily digital video broadcast enhanced with interactivity. At the simplest level the Interactive channel allows the consumer to react by voting, to order articles displayed in the broadcast programme, to select certain programme bouquets or to choose movies in near-video-on-demand systems. It is also possible to deliver text, graphics, audio and still pictures (including e-mail) on-demand, although this may require an interactive channel with higher bitrates.

There are many possible network configurations covering the currently specified DVB broadcast options including satellite, terrestrial, cable, SMATV and MMDS in conjunction with PSTN, ISDN, cable and other Interactive channel options. The network dependent protocols are specified in ETS 300 800 [3], ETS 300 801 [4], ETS 300 803 [5].

The implications for interactive services via these types of networks will be described in a separate guidelines document ETR XXX [2] which will also summarise the functionality of the protocols identified in this ETS.

2 Normative references

This ETS incorporates by dated and undated reference, provisions from other publications. These normative references are cited at the appropriate places in the text and the publications are listed hereafter. For dated references, subsequent amendments to or revisions of any of these publications apply to this ETS only when incorporated in it by amendment or revision. For undated references the latest edition of the publication referred to applies.

- [1] ISO/IEC 13818-6: "Information Technology: Coding of moving pictures and associated audio - Part 6 - Digital Storage Media Command and Control (DSM-CC).
- [2] ETR XXX: "Digital Video Broadcasting (DVB); Guidelines for the use of the DVB Specification : Network Independent Protocols for Interactive Services (ETS 300 802)."
- [3] ETS 300 800: "Digital Video Broadcasting (DVB); DVB interaction channel through CATV Networks".
- [4] ETS 300 801: "Digital Video Broadcasting (DVB); DVB interaction channel through PSTN/ISDN".
- [5] ETS 300 803: "Digital Video Broadcasting (DVB); DVB interaction channel for Satellite Master Antenna TV distribution systems (SMATV)".
- [6] ETS 300 468: "Digital Video Broadcasting (DVB); Specification for Service Information (SI) in DVB streams."
- [7] ETR 211: "Digital Video Broadcasting (DVB); Guidelines for the Implementation and Usage of Service Information (SI) in DVB streams."
- [8] ETS 300 XXX: "Digital Video Broadcasting (DVB); Specification for Data Broadcasting Services in DVB."
- [9] RFC 768 (UDP) "User Datagram Protocol", J. Postel, 28.08.1980.
- [10] RFC 791 (IP) "Internet Protocol", J. Postel, 01.09.1981.
- [11] RFC 793 (TCP) "Transmission Control Protocol", J. Postel, 01.09.1981.
- [12] RFC 1332 (IPCP) "The PPP Internet Protocol Control Protocol", G. McGregor, 26.05.1992.
- [13] RFC 1661 (PPP): "The Point-to-Point Protocol", W. Simpson, 21.07.1994.
- [14] RFC 1662: "PPP in HDLC-like Framing", W. Simpson, 21.07.1994.
- [15] RFC 1700: "Assigned Numbers", J. Reynolds, J. Postel, 20.10.1994.

- [16] “Universal Network Object Specification”, Version 1.0 (identical to OMG-UNO Specification for CORBA 2.0)
- [17] RFC 1717 (MP): “The PPP Multilink Protocol”, K. Sklower, B. Lloyd, G. McGregor, D. Carr, T. Coradetti, 16.08.96.

3 Abbreviations

For the purposes of this ETS, the following abbreviations apply:

AAL	ATM Adaptation Layer
ACD/ACD	Application Control Data / Application Communication Data
API	Application Programming Interface
ASN.1	Abstract Syntax Notation One
ATM	Asynchronous Transfer Mode
BER	Basic Encoding Rules
CATV	Common Antenna Television
CHAP	Challenge Handshake Authentication Protocol
DAVIC	Digital AudioVisual Council
DDC	Data Download Control
DSM-CC	Digital Storage Media - Command and Control
DSM-CC U-N	DSM-CC User-to-Network
DSM-CC U-U	DSM-CC User-to-User
DVB	Digital Video Broadcasting
HFC	Hybrid Fibre Coax
IETF	Internet Engineering Task Force
IIOF	Internet Inter-ORB Protocol
IOR	Interoperable Object Reference
IP	Internet Protocol
IPCP	Internet Protocol Control Protocol
ISDN	Integrated Services Digital Network
LCP	Link Control Protocol
LLC	Link Layer Control
MIB	Management Information Base
MMDS	Multipoint Microwave Distribution System
MP	Multilink Point-to-Point Protocol (PPP)
MPEG	Moving Picture Experts Group
MPEG TS	MPEG Transport Stream
NSAP	Network Services Access Point
OSI	Open Systems Interconnection
PAP	Password Authentication Protocol
PPP	Point-to-Point Protocol
PSTN	Public Switched Telephone Network
RFC	Request For Comments
RPC	Remote Procedure Call
RTP	Real Time Protocol
SI	Service Information
SIS	Systems for Interactive Services
SMATV	Satellite Master Antenna Television
SNAP	Sub Network Attachment Point
SNMP	Simple Network Management Protocol
SRM	Session and Resource Manager
STB	Set Top Box
STU	Set Top Unit
TCP	Transmission Control Protocol
UDP	User Datagram Protocol
UNO-CDR	Universal Networked Object - Common Data Representation
UNO-RPC	Universal Networked Object - Remote Procedure Call

4 Protocol Stack and System models

4.1 Protocol Stack model

Within the DVB commercial requirements for asymmetric interactive services supporting broadcast to the home with narrowband return channel (see annex A: Bibliography) a simple communications model has been used to identify the necessity and importance of each commercial requirement consisting of the following layers:

Physical layer: where all the physical (electrical) transmission parameters are defined.

Transport layer: defines all the relevant data structures and communication protocols like data containers, etc.

Application layer: is the interactive application software and runtime environments (e.g. home shopping application, script interpreter, etc.).

The DVB specifications [3], [4], [5] address the lower two layers (the physical and transport) leaving the application layer open to competitive market forces.

The DVB adopted a simplified model of the OSI layers to facilitate the production of specifications for these nodes.

Figure 1 points out the lower three layers of the simplified model and identifies some of the key parameters.

Following the User requirements for interactive services, this specification does not consider higher layers. This approach is in broad agreement to that proposed by other bodies such as DAVIC (see annex A: Bibliography).

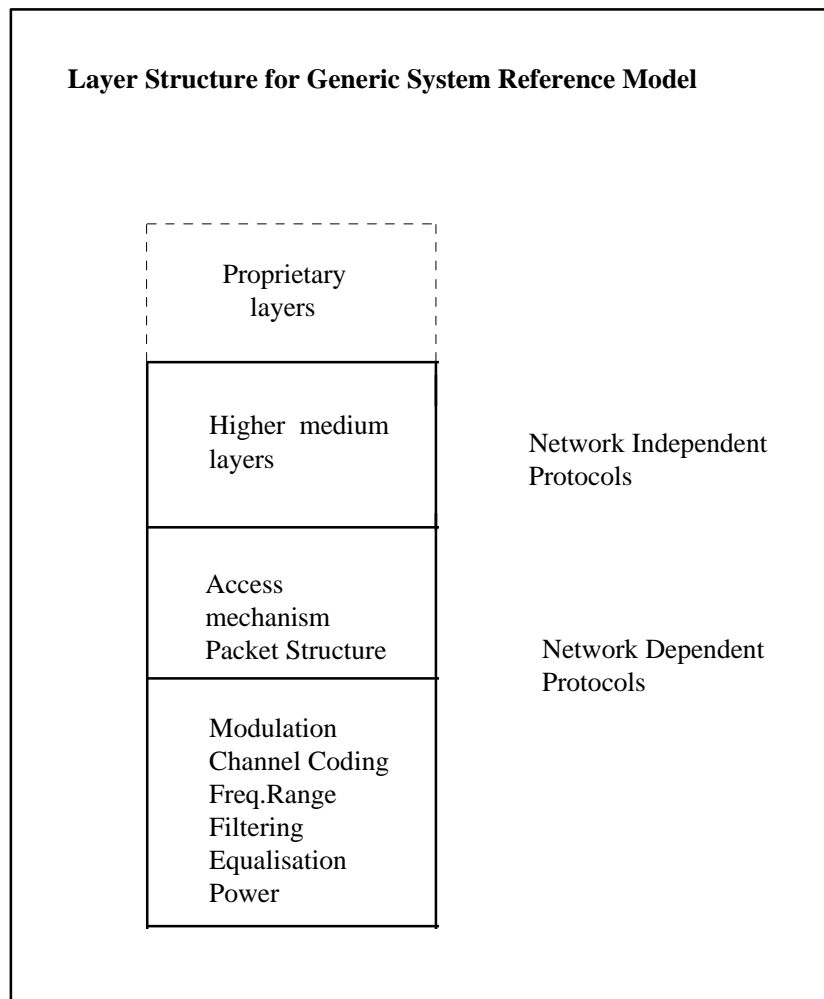

Figure 1: Layer structure for generic system Reference model

This specification addresses the network independent protocols only, up to layer 4 on the OSI stack in most cases. The network dependent protocols within the transport layer and the physical layers for different network options will be specified separately. Specifications for PSTN/ISDN [4], CATV [3], and SMATV/MATV [5] networks are currently being prepared.

4.2 System model

Figure 2 shows the system model which is to be used within DVB for interactive services.

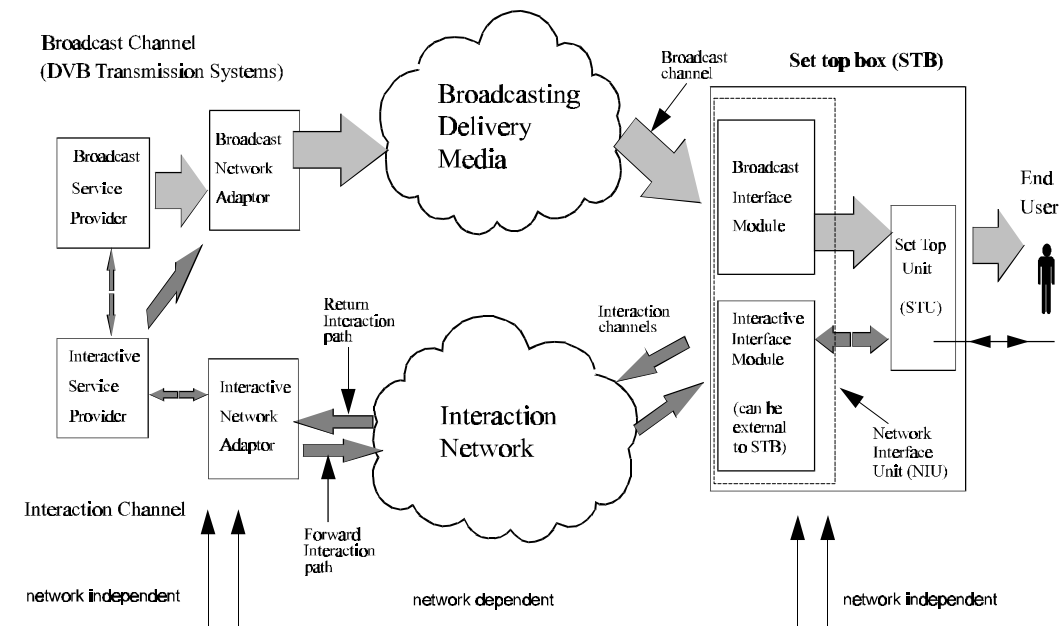

Figure 2: A generic system Reference Model for Interactive Systems

In the system model, two channels are established between the User and the Service Provider: the Broadcast channel and the Interaction channel.

Broadcast channel: A unidirectional broadband Broadcast channel including video, audio and data. The Broadcast channel is established from the Service Provider to the Users. It may include the Forward Interaction path.

Interaction channel: A Bi-directional Interaction channel is established between the User and the Service Provider for interaction purposes. It is formed by:

Return Interaction path from the User to the Service Provider is a narrowband channel, commonly known as Return channel, which is used to make requests to the Service Provider or to answer questions.

Forward Interaction path from the Service Provider to the User is used to provide some sort of information by the Service Provider to the User and any other required communication for the interactive service provision. It may be embedded into the Broadcast channel. It is possible that this channel is not required in some simple implementations which make use of the Broadcast channel for the carriage of data to the User.

4.3 Logical model

Figure 3 shows the mapping of logical channels onto the system model.

The Broadcast channel carries Content from the Broadcast Service Provider and, in some instances, from the Interactive Service Provider to the User. The Broadcast channel may also carry embedded ACD/ACD and/or DDC from the Interactive Service Provider to the User, possibly for controlling an application for which Broadcast Programme Associated Data is being supplied by the Interactive Service Provider.

The Interaction channel carries Content from the Interactive Service Provider to the User, and may also carry User Contribution Content back to the Interactive Service Provider. The Interaction channel also carries ACD/ACD to and from the User, and may also carry DDC to the User.

The Interactive Service Provider may also need to send Content, either to the Broadcast Service Provider, or to the Broadcast Network Adapter. The latter will require the Interactive Service Provider to send ACD/ACD and/or DDC to the Broadcast Network Adapter for embedding in the Broadcast channel. A bi-directional Application Control & Communication channel will also be required between the Broadcast Service Provider and the Interactive Service Provider for synchronisation purposes.

The network independent protocol stacks are derived from the logical channel terminology specified by DAVIC i.e. S1 to S5 flows. This terminology is explained in [2].

The following basic realisations of mapping logical streams S1, S2 onto the system model are possible as illustrated in figure 3 :

- (a) Broadcast channel carries S1 from Broadcast Service Provider or from Interactive Service Provider to the User;

Broadcast channel carries S2 (ACD/ACD and/or DDC) forward to the User;

Interaction channel carries S2 backward (ACD/ACD).

- (b) Broadcast channel carries S1 as in (a);

Interaction channel carries S2 forward (ACD/ACD and /or DDC) and S2 backward (ACD/ACD).

- (c) Interaction channel carries S1 from Interactive Service Provider to the User;

Interaction channel carries S2 as in (b).

- (d) Interaction channel carries S1 (User Contribution Content) from the User back to the Interactive Service Provider or to the Broadcast Service Provider;

Interaction channel carries S2 as in (b).

The SIS protocol stacks provide a generic solution for communication between a STB and a network. In the case where a direct connection between a STB and an Interactive Service Provider exists, the SIS protocol stacks provide a solution for the STB and the server. Where there is not a direct connection to an Interactive Service Provider (e.g. in traversing multiple networks), the protocol stack at the server end may be different to the STB stack for the mapping between the IP layer and the underlying physical layer (an example of this is a point-to-point connection from the STB to the first point of presence in the network, with an X.25 connection from the network to the Interactive Service Provider).

Note that an exception to the use of PPP is acceptable as an option, in the case of a cable return channel, where IP may be carried over ATM. In this case, LLC/SNAP as defined in RFC 1483 (see Annex 1: Bibliography) shall be used for encapsulating the IP over AAL5. The default MTU size shall be 9180 bytes as defined in RFC 1577 (see Annex 1: Bibliography). If another case arises where a PPP link is not used then an equivalent encapsulation method will be specified as part of the network dependent protocol stack.

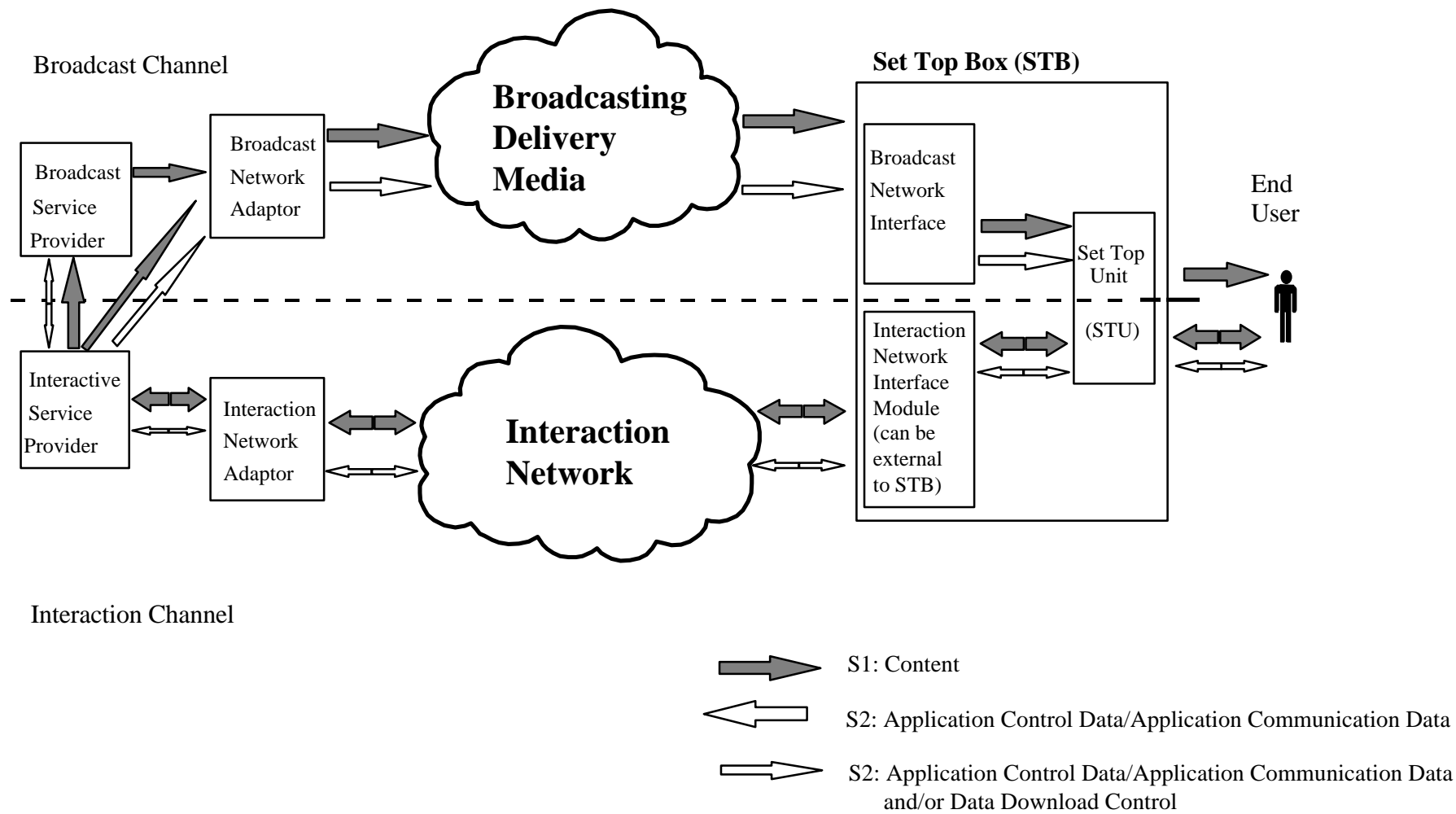

Figure: 3: Mapping of S1 and S2 Logical Channel onto System Model

5 Protocol stacks

The protocols stacks specified comply to the references as listed in clause 2.0 of this ETS. The protocol stacks and their use are explained in [2].

5.1 S1 - Broadcast or Narrowcast Content - audio, video, data

Broadcast channel: two categories are provided:

- (i) DVB specified transmission system;
- (ii) DVB specified transmission system with UDP/IP or TCP/IP with an Interaction channel return flow.

Table 1: UDP/IP or TCP/IP via Broadcast channel

UDP	TCP
IP	
MPEG2 Private Section (DSM-CC Section)	
MPEG2 TS	

The mechanism for transmitting IP within MPEG-2 Private Sections (DSM-CC Sections) will be as defined in [8]. Where TCP/IP is carried over the Broadcast channel, an interaction channel must be established for the flow of return acknowledgements.

Interaction channel : This allows for the exchange of both time sensitive (synchronised) and non-time sensitive (non-synchronised) content information and application data via the interaction channel. Time sensitive content information consists of streams which have to be delivered in real time. Non-time sensitive content information consists of files whose delivery does not need to be in real time.

(i) Synchronised data:

Table 2: Synchronised data via Interaction channel

UDP
IP
PPP(MP)

RTP may optionally be used above UDP for critical real time communication. RTP provides information about the coding scheme used in the payload and time stamps to enable receivers to regenerate sender timing. Control messages are also used to monitor connection quality and to identify participants in a multi-user session. Note that RTP relies on software decompression which requires significant CPU resources.

(ii) Non-synchronised data:

Table 3: Non-synchronised data via Interaction channel

TCP
IP
PPP(MP)

Standard TCP is adequate for delivery of content up to 150 kbit/s, but if it is required to deliver data at a higher rate, via a long delay network, then extensions to TCP exist which can be implemented. These implementations will be backwards compatible with standard TCP implementations. If this option is used, then the extensions of TCP shall be according to RFC 1323 [12].

5.2 S2 - ACD/ACD and DDC between Server and STB

Broadcast channel : Two categories are provided:

- (i) Download of data across the Broadcast channel

Table 4: DDC via Broadcast channel

DSM-CC Data Carousel
MPEG2 Private Section (DSM-CC Section)
MPEG2 TS

- (ii) ACD/ACD - User-to-user interaction across the Broadcast channel

Table 5: ACD/ACD via Broadcast channel

DSM-CC U-U
DSM-CC Object Carousel
DSM-CC Data Carousel
MPEG2 Private Section (DSM-CC Section)
MPEG2 TS

In table 5 above DSM-CC U-U is only used for the API. The DSM-CC Object Carousel specification describes the transportation of the U-U objects (and their attributes) in the Broadcast channel. The objects within the Object Carousel can either be broadcast in the Object Carousel itself or can be located at an interactive server. If necessary the identification of the interactive server (e.g. PSTN/ISDN telephone number) can be communicated to STB by including the ServiceLocationComponent structure (defined in DSM-CC U-U) in the IOR of the object. The ServiceLocationComponent shall contain a 20 Bytes E.164 NSAP address which conveys the identification information, as defined in [8].

Interaction channel: two categories are provided:

- (i) Download of data across the Interaction channel

Table 6: DDC via Interaction channel

DSM-CC Download
TCP
IP
PPP(MP)

- (ii) ACD/ACD - User-to-user interactions across the Interaction channel

Table 7: ACD/ACD via Interaction channel

DSM-CC U-U
UNO-CDR, UNO-RPC
TCP
IP
PPP(MP)

The UNO-RPC consists of the Internet Inter-ORB Protocol (IIOP) as specified in RFC 1717 (MP) [17].

5.3 S3 - Session control signalling

Session control protocols are not normally required in STBs for DVB interactive services. If as an option it is required to allow for services using session control, then the protocols used shall be as listed below. As resource allocation is not normally required for the point-to-point connection, resource descriptors in session set-up messages are not normally needed.

Table 8: Session control via Interaction channel (optional)

DSM-CC U-N subset
UDP
IP
PPP(MP)

The subset of messages required is as follows:

Session Setup Sequence:

ClientSessionSetupRequest / ClientSessionSetupConfirm

Client Initiated Session Release Sequence:

ClientReleaseRequest / ClientReleaseConfirm

Server Initiated Release Sequence:

ClientReleaseIndication / ClientReleaseResponse

Status Inquiry Sequence:

ClientStatusIndication / ClientStatusResponse

Connection Reset Sequence:

ClientResetRequest / ClientResetIndication

For implementation of session control signalling see clause 8.

An exception to the above is in the case where session control is used on the interaction channel and IP data is carried within the MPEG2 stream through the broadcast channel (see 5.1 (ii) above). In this case, resource descriptors may optionally be used. When the STB opens the service which uses IP over the MPEG2 TS, a session is established on the interaction channel. The STB then receives the required signalling parameters via the interaction channel using the resource descriptors as specified below as part of the ClientSessionSetUpConfirm message.

The IP packets are carried in the MPEG2 TS using the DVB specified datagram_section as defined in [8]. The parameters required for locating the stream where the packets are carried, can be signalled on the interaction channel by using either a MpegProgram descriptor as specified in [1], which defines the physical parameters directly, or by using the DVB Service Component descriptor which uses the SI data indirection mechanisms (see [7]) to provide a physical network independent location mechanism. A MAC address descriptor can also be used for assigning a MAC address to the STB that it will use for filtering the packets. If the MAC address is allocated statically for each client or is provisioned through some other mechanism, this descriptor is not used.

These resource descriptors are described below:

- MpegProgram descriptor (descriptor_type = 0x0003) as defined in [1] contains the PID in which the packets are carried.
- DVB Service Component descriptor (descriptor_type = 0xffff, typeOwnerId = <OUI of DVB (?)> (to be supplied by the DVB office when it is allocated by the IEEE), typeOwnerValue = 0x000001):

Field Name	Encoding	Variable	Field Length In Bytes
original_network_id	s	no	2
transport_stream_id	s	no	2
service_id	s	no	2
component_tag	s,l	yes	1

original_network_id, transport_stream_id and service_id identify the service uniquely in a DVB network.

component_tag field can be used to indicate the components of the service that are used. If the component_tag field is a list of length 0, all components of the service are used.

- DVB MAC address descriptor (descriptor_type = 0xffff, typeOwnerId = <OUI of DVB (?)> (to be supplied by the DVB office when it is allocated by the IEEE), typeOwnerValue = 0x000002):

Field Name	Encoding	Variable	Field Length In Bytes
ipAddress	s,l	yes	4
macAddress	s	no	6
macAddressRange	s	no	1

The ipAddress field shall contain the IP address(es) of the client.

The macAddress field shall contain the MAC address assigned to the client.

The macAddressRange shall indicate the number of valid bytes in the end of the MAC address needed for filtering.

5.4 S4 - Connection control signalling

Network dependent so not defined here. (see annex A: Bibliography: “DAVIC”).

5.5 S5 - Capability Transfer and Network Management

Capability Transfer: DSM-CC User Compatibility Management

Network Management: the implementation of remote diagnostics via the Interaction channel using the Network Management stack shown in table 9 is optional for DVB interactive services.

Table 9: Network Management via Interaction channel (optional)

SNMP MIB
ASN.1 BER
SNMP
UDP
IP
PPP(MP)

Implementation of the SNMP MIB shall be as specified in annex A of this ETS.

Clause 7 of [3] gives a brief informative description of the SNMP MIB. The MIB provides links to the DSM-CC User Compatibility Management fields.

6 PPP data link setup

After the STB has been connected through the interaction network to the server, the PPP configuration process is initiated. This configuration process consists of the following phases:

- (1) Link Control Protocol (LCP, see RFC 1661 [13]) is used to establish the data link connection;
- (2) IPCP (RFC 1332 [12]) is used to configure IP and the type of compression.

In phase (1) and (2), both “Configure-Request” and “Configure-Ack” packets are sent and received. In phase (2), the STB sends a Configure-Request packet that includes the IP Address configuration fields at the beginning. In this case, PPP facilitates the transfer of an IP address from the Interactive Service Provider during the initialisation phase of PPP.

Optionally, authentication of the STB can be done using the Password Authentication Protocol (PAP) and Challenge Handshake Authentication Protocol (CHAP), both as specified in RFC 1994 (see annex A: Bibliography).

6.1 PPP configuration for IP transmission

For compression of the IP Address and Control Fields (see RFC 1332 [12]), the following protocols shall be supported in the PPP data link layer (see RFC 1340 - Assigned numbers Page 65):

0021	Internet Protocol;
002d	Van Jacobson Compressed TCP/IP;
002f	Van Jacobson Uncompressed TCP/IP.

For the PPP link, the following configuration shall be supported as recommended for PSTN type links (Appendix A to RFC 1662 [12]):

- Async Control Character Map;
- Magic Number;
- Address and Control Field Compression;
- Protocol Field Compression.

7 Network congestion control

Where a large number of (near) simultaneous transactions may be generated by a popular broadcast, a means of avoiding network congestion shall be provided in the interactive application. Guidance on implementation of network congestion control is given in clause 8 of ETR XXX [2].

8 Session control in DVB interactive services

8.1 Introduction

End-to-end session control is needed for certain services and network configurations. If a session control protocol is used, the protocol stack shall be as defined in subclause 5.3 of this ETS. A subset of DSM-CC User-to-Network protocol [1] is used. Resource management features of the User-to-Network protocol are not normally needed for DVB networks. The syntax of the User-to-Network messages is defined in chapter 4 of [1].

In the DSM-CC reference model the client and the server use the User-to-Network protocol to communicate with a session and resource manager (DSM-CC SRM). In a simple service environment, the session and resource manager can be integrated with the server because only the session management is needed.

8.2 Session establishment

After setting up the connection, the STB establishes an end-to-end session to the server using the DSM-CC U-N session set-up sequence (figure 4). The object reference to the service root directory is returned with the confirm message.

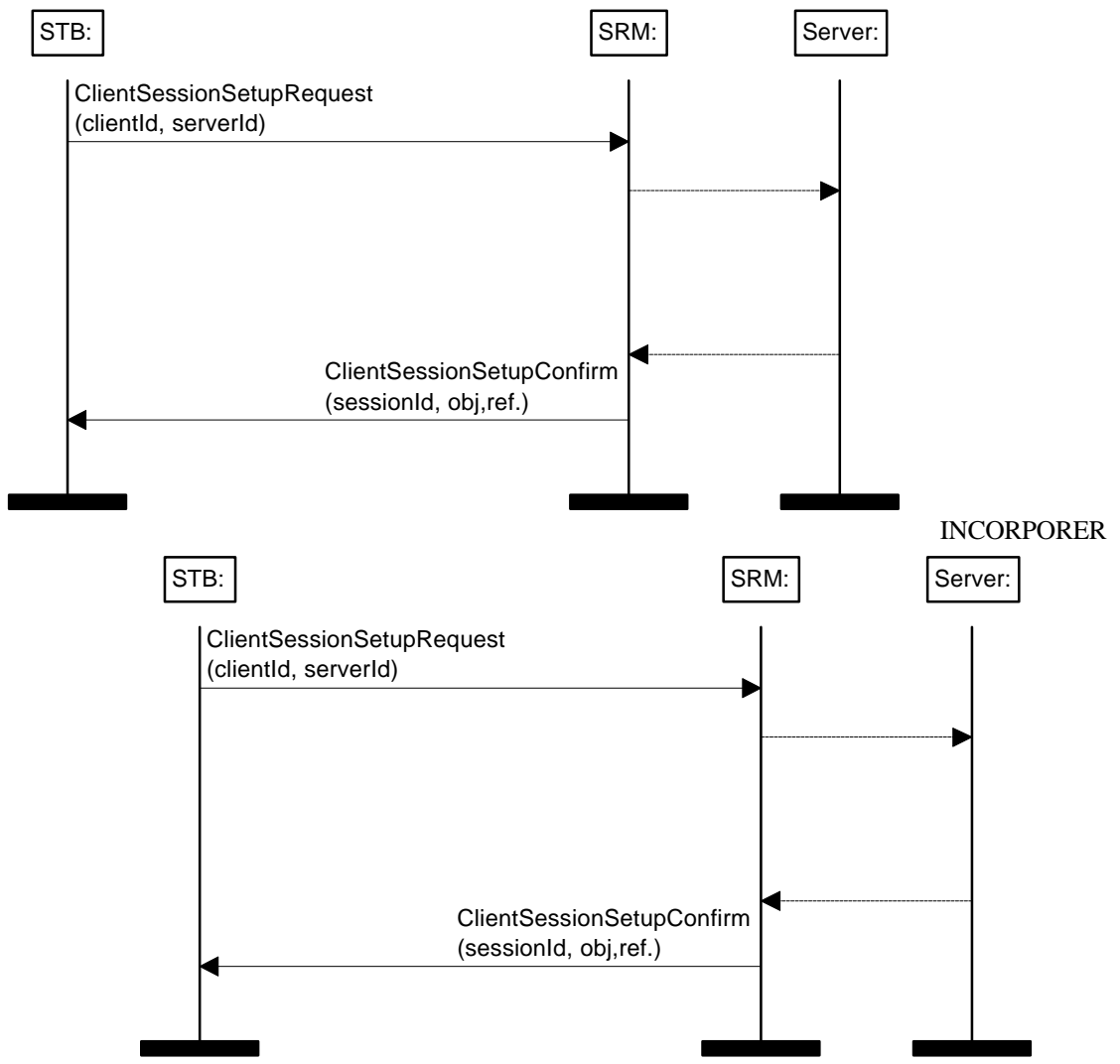

Figure 4: Session set-up sequence

8.3 Session release

When the STB wants to close the session, it uses the client-initiated session release sequence (figure 5). After that, the connection can be closed.

When the server receives the session release message, it can close all objects related to the session and shut down the service for the session.

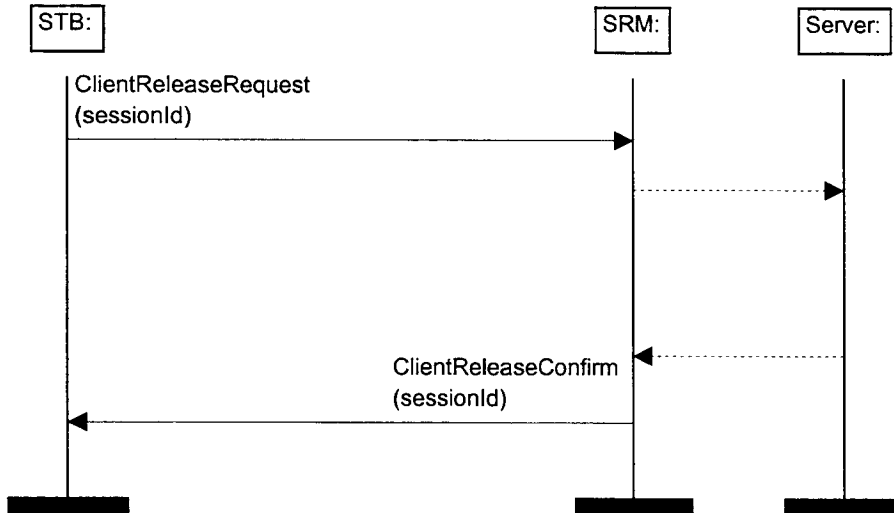

Figure 5: Client-initiated session release sequence

If the server wants to close a session, it can use the server-initiated session release sequence (figure 6).

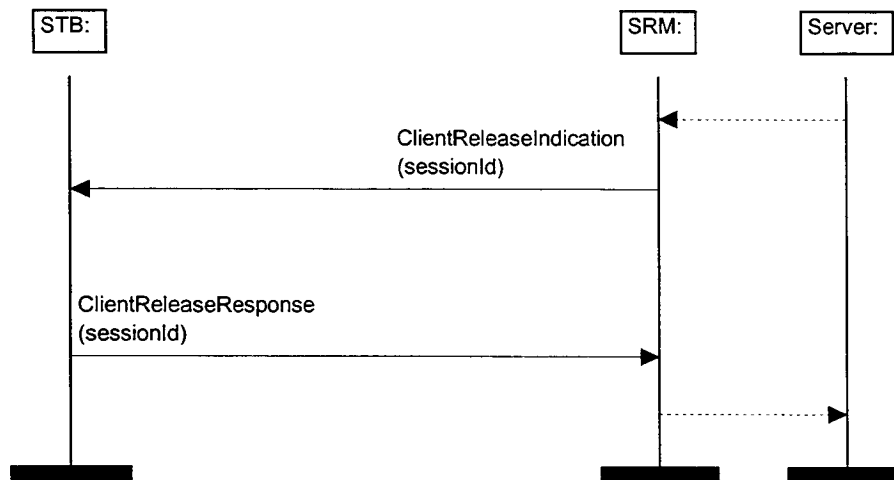

Figure 6: Server-initiated session release sequence

8.4 Status inquiry

The SRM can check if the client is still connected by sending a status indication message and checking the response of the client (figure 7).

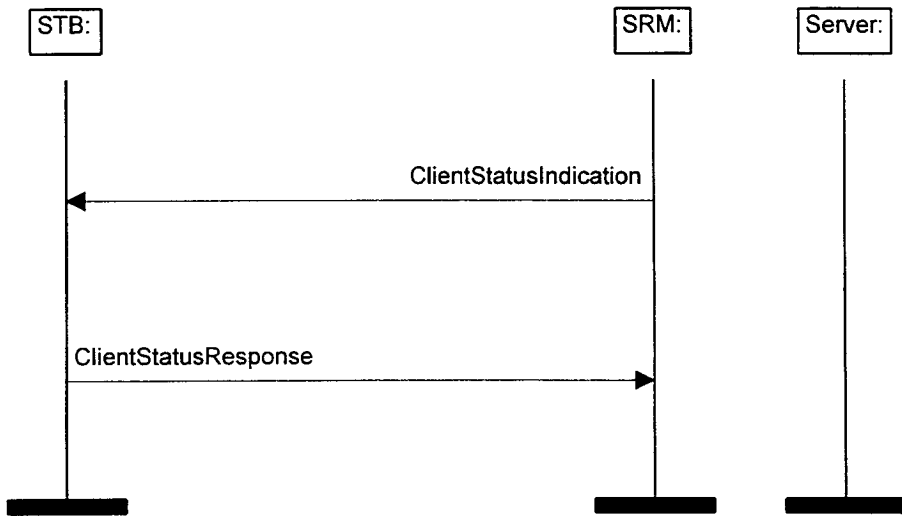

Figure 7: Status inquiry sequence

8.5 Connection reset

In an abnormal situation, the client can close all the sessions and reset the connection by sending a ClientResetRequest message to the SRM. Normally the sessions should be closed with the session release sequence. The reset message should be used only in extraordinary situation such as if the client has an open session but has somehow lost the sessionId.

The SRM can also close all the sessions for a client by sending a ClientResetIndication. This shall also be used only in abnormal situations.

Annex A (informative): Bibliography

- DVB A008 "Commercial Requirements for Asymmetric Interactive Services Supporting Broadcast to the Home with Narrowband Return channels", European Project for Digital Video Broadcasting (DVB), October 1995.
- DAVIC 1.0 Part 07 'High and Mid Layer Protocols (Technical Specification)', January 1996
- RFC 1157 (SNMP) 'A Simple Network Management Protocol (SNMP)', M. Schoffstall, M. Fedor, J. Davin, J. Case, 10.05.1990.
- RFC 1323 'TCP Extensions for High Performance', D. Borman, R. Braden, V. Jacobsen, 13.05.1992.
- RFC 1483 'Multiprotocol Encapsulation over ATM Adaptation Layer 5', J Heinanen, 20.07.1993
- RFC 1577 'Classical IP and ARP over ATM', M Lauback, 20.01.1994.
- RFC 1889 (RTP) 'RTP : A Transport Protocol for Real-Time Applications', 25.01.1996.
- RFC 1994 (CHAP) 'PPP Challenge Handshake Authentication Protocol', W. Simpson, 30.08.1996.