

## **Digital Video Broadcasting (DVB); Interaction channel for Cable TV distribution systems (CATV); Guidelines for the use of ETS 300 800**

---

European Broadcasting Union



Union Européenne de Radio-Télévision

**DVB**  
Digital Video  
Broadcasting



*European Telecommunications Standards Institute*

---

---

**Reference**

DTR/JTC-DVB-61 (b2o00ics.PDF)

---

**Keywords**

broadcasting, digital, video, DVB, TV

***ETSI Secretariat***

---

**Postal address**

F-06921 Sophia Antipolis Cedex - FRANCE

---

**Office address**

650 Route des Lucioles - Sophia Antipolis  
Valbonne - FRANCE  
Tel.: +33 4 92 94 42 00 Fax: +33 4 93 65 47 16  
Siret N° 348 623 562 00017 - NAF 742 C  
Association à but non lucratif enregistrée à la  
Sous-Préfecture de Grasse (06) N° 7803/88

---

**X.400**

c= fr; a=atlas; p=etsi; s=secretariat

---

**Internet**

secretariat@etsi.fr  
<http://www.etsi.fr>

---

***Copyright Notification***

No part may be reproduced except as authorized by written permission.  
The copyright and the foregoing restriction extend to reproduction in all media.

© European Telecommunications Standards Institute 1997.  
© European Broadcasting Union 1997.  
All rights reserved.

---

# Contents

Intellectual Property Rights.....	4
Foreword .....	4
1 Scope.....	5
2 References.....	5
3 Abbreviations.....	5
4 System model.....	6
5 Protocol stack model.....	7
6 Specification outline .....	8
6.1 Bit rates and framing.....	9
6.2 Lower physical layer specification.....	10
6.3 MAC layer specification .....	12
6.3.1 MAC reference model.....	12
6.3.2 MAC concept .....	13
6.3.3 MAC messages.....	14
7 Network architecture and services .....	15
7.1 Examples of services.....	15
7.2 Examples of networks with interactive services.....	16
7.3 Possible links between servers and HFC networks .....	16
7.4 Frequency use .....	16
7.5 Impairments analysis.....	17
7.6 Dimensioning of networks .....	20
8 Tools provided by the physical and MAC layer .....	21
8.1 Capabilities and grades of NIU.....	21
8.2 Upstream frequencies dynamic allocation .....	22
8.3 Initialization and set-up.....	22
9 Connections management .....	22
9.1 Connection protocol and bandwidth assignment.....	23
9.2 Interface between MAC and medium higher layers (ATM).....	24
9.3 Disconnection protocol.....	24
10 Simulation of error performance and error handling .....	24
10.1 Error performance of the physical layer.....	24
10.2 Traffic .....	27
10.3 Error handling.....	27
History .....	28

---

## Intellectual Property Rights

IPRs essential or potentially essential to the present document may have been declared to ETSI. The information pertaining to these essential IPRs, if any, is publicly available for **ETSI members and non-members**, and can be found in ETR 314: "*Intellectual Property Rights (IPRs); Essential, or potentially Essential, IPRs notified to ETSI in respect of ETSI standards*", which is available **free of charge** from the ETSI Secretariat. Latest updates are available on the ETSI Web server (<http://www.etsi.fr/ipr>).

Pursuant to the ETSI Interim IPR Policy, no investigation, including IPR searches, has been carried out by ETSI. No guarantee can be given as to the existence of other IPRs not referenced in ETR 314 (or the updates on <http://www.etsi.fr/ipr>) which are, or may be, or may become, essential to the present document.

---

## Foreword

This Technical Report (TR) has been produced by Joint Technical Committee (JTC) of the European Broadcasting Union (EBU), Comité Européen de Normalisation Electrotechnique (CENELEC) and the European Telecommunications Standards Institute (ETSI).

**NOTE:** The EBU/ETSI JTC was established in 1990 to co-ordinate the drafting of standards in the specific field of broadcasting and related fields. Since 1995 the JTC became a tripartite body by including in the Memorandum of Understanding also CENELEC, which is responsible for the standardization of radio and television receivers. The EBU is a professional association of broadcasting organizations whose work includes the co-ordination of its members' activities in the technical, legal, programme-making and programme-exchange domains. The EBU has active members in about 60 countries in the European broadcasting area; its headquarters is in Geneva.

European Broadcasting Union  
CH-1218 GRAND SACONNEX (Geneva)  
Switzerland  
Tel: +41 22 717 21 11  
Fax: +41 22 717 24 81

### Digital Video Broadcasting (DVB) Project

Founded in September 1993, the DVB Project is a market-led consortium of public and private sector organizations in the television industry. Its aim is to establish the framework for the introduction of MPEG2 based digital television services. Now comprising over 200 organizations from more than 25 countries around the world, DVB fosters market-led systems, which meet the real needs, and economic circumstances, of the consumer electronics and the broadcast industry.

---

## 1 Scope

The present document gives guidelines for use of the DVB interaction channel for Cable TV distribution systems (CATV) specification ETS 300 800 [1].

Hybrid Fibre Coax (HFC) networks are a sub-class of CATV networks in which the subscribers are divided into groups by using optical transmission technology in the trunk network.

The CATV infrastructures can support the implementation of the RC for interactive services suitable for DVB broadcasting systems. CATV can be used to implement interactive services in the DVB environment, providing a bi-directional communication path between the user terminal and the service provider.

---

## 2 References

References may be made to:

- a) specific versions of publications (identified by date of publication, edition number, version number, etc.), in which case, subsequent revisions to the referenced document do not apply; or
- b) all versions up to and including the identified version (identified by "up to and including" before the version identity); or
- c) all versions subsequent to and including the identified version (identified by "onwards" following the version identity); or
- d) publications without mention of a specific version, in which case the latest version applies.

A non-specific reference to an ETS shall also be taken to refer to later versions published as an EN with the same number.

- [1] ETS 300 800: "Digital Video Broadcasting (DVB); Interaction channel for Cable TV distribution systems (CATV)". (known also as the "DVB-RCC spec).
- [2] EN 300 429: "Digital Video Broadcasting (DVB); Framing structure, channel coding and modulation for cable systems". (known also as the "DVB-C spec).
- [3] ITU-T Recommendation I.363: "B-ISDN ATM Adaptation Layer (AAL) specification".

---

## 3 Abbreviations

For the purposes of the present document, the following abbreviations apply:

AAL5	ATM Adaptation Layer 5
ATM	Asynchronous Transfer Mode
BC	Broadcast Channel
BIM	Broadcast Interface Module
BRA	Basic Rate Access
CATV	Cable TV distribution system
CB radio	Citizens' Band radio
DAVIC	Digital Audio - Visual Council
EMC	ElectroMagnetic Compatibility
FIP	Forward Interaction Path
HFC	Hybrid Fibre Coax
IB	In-Band
IC	Interaction Channel
ID	IDentifier
IEEE	Institute of Electrical and Electronics Engineers
IIM	Interactive Interface Module

INA	Interactive Network Adapter
IP	Internet Protocol
IRD	Integrated Receiver Decoder
ISDN	Integrated Services Digital Network
LAN	Local Area Network
LLC	Link Layer Control
MAC	Media Access Control
MPEG	Moving Picture Export Group
NIU	Network Interface Unit
ONU	Optical Node Unit
OOB	Out-Of-Band
OSI	Open Systems Interconnection
PSTN	Public Switched Telephone Network
RC	Return Channel
RCC	Return Channel - Cable
RIP	Return Interaction Path
RMS	Root Mean Square
SDH	Synchronous Digital Hierarchy
SMATV	Satellite Master Antenna Television
SNR	Signal to Noise power Ratio
STB	Set Top Box
STU	Set Top Unit
TCP	Transmission Control Protocol
TDMA	Time Division Multiple Access
TS	Transport Stream
UC	Upstream Channel
VCI	Virtual Channel Identifier
VPI	Virtual Path Identifier

---

## 4 System model

Figure 1 shows the system model which is to be used within DVB for interactive services.

In the system model, two channels are established between the service provider and the user:

- **Broadcast Channel (BC):** A uni-directional broadband BC including video, audio and data. BC is established from the service provider to the users. It may include the Forward Interaction Path (FIP).
- **Interaction Channel (IC):** A Bi-directional interaction channel is established between the service provider and the user for interaction purposes. It is formed by:
  - **Return Interaction Path (RIP):** From the user to the service provider. It is used to make requests to the service provider or to answer questions. Also commonly known as Return Channel (RC) or Upstream Channel (UC).
  - **Forward Interaction Path (FIP):** From the service provider to the user. It is used to provide some sort of information by the service provider to the user and any other required communication for the interactive service provision. It may be embedded into the BC. It is possible that this channel is not required in some simple implementations which make use of the BC for the carriage of data to the user.

In the present document the word "channel" denotes logical link and "path" corresponds to a physical link.

The user terminal is formed by the Network Interface Unit (NIU) (consisting of the Broadcast Interface Module (BIM) and the Interactive Interface Module (IIM)) and the Set Top Unit (STU). The user terminal provides interface for both broadcast and interaction channels. The interface between the user terminal and the interaction network is via the IIM.

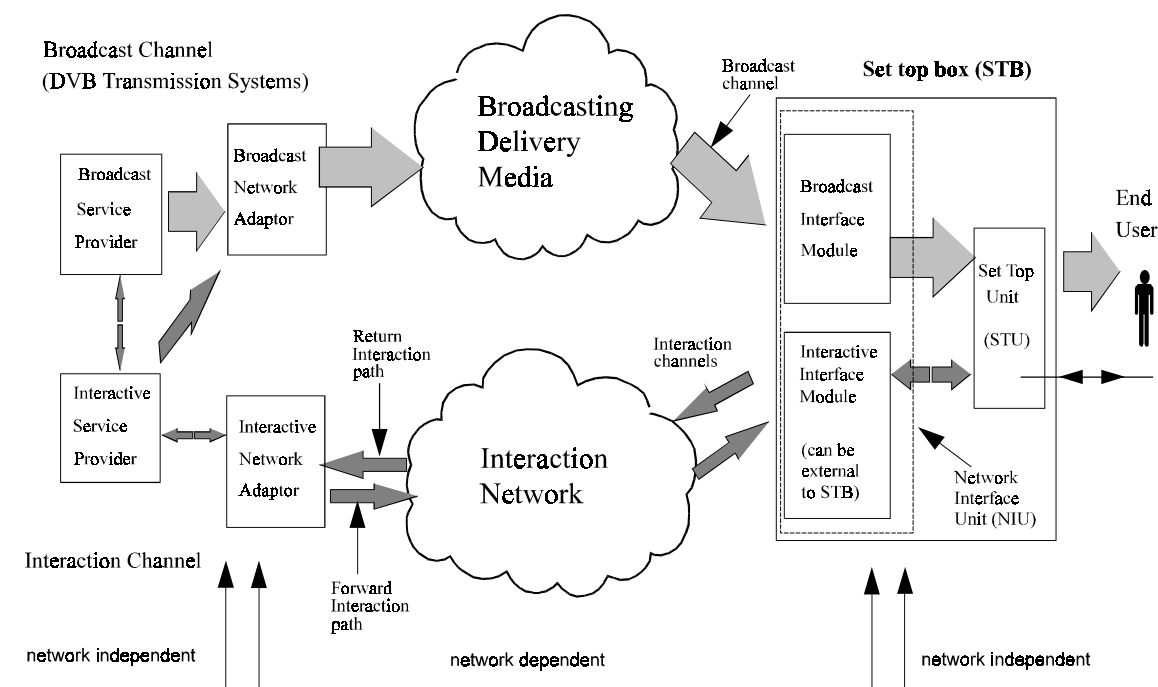

**Figure 1: Generic system reference model for interactive systems**

The interactive system is composed of FIP (downstream) and RIP (upstream). The general concept is to use FIP to act as a transmission medium for MAC control channel and to carry a part of the downstream data. This allows the NIUs to adapt to the network and send synchronized information upstream.

RIP is divided into time slots which can be used by different users, using the technique of Time Division Multiple Access (TDMA). One MAC control channel is used to control up to 8 UCs, which are all divided into time slots. A time marker and an upstream counter at the INA is sent periodically to the NIUs, so that all NIUs work with synchronized clock and same upstream counter value. This gives the opportunity to the INA to assign time slots to different users.

Three major access modes are provided with this system. The first one is based on contention access, which lets users send information at any time with the risk to have a collision with other user's transmissions. The second and third modes are contention-less based, where the INA either provides a finite amount of slots to a specific NIU, or a given bit rate requested by a NIU until the INA stops the connection on NIU's demand. These access modes are dynamically shared among time slots, which allows NIUs to know when contention based transmission is or is not allowed. This is to avoid a collision for the two contention-less based access modes.

Periodically, the INA will indicate to new users that they have the possibility to go through sign-on procedure, in order to give them the opportunity to synchronize their clock to the network clock, without risking collisions with already active users. This is done by leaving a larger time interval for new users to send their information, taking into account the propagation time required from the INA to the NIUs and back.

## 5 Protocol stack model

For asymmetric interactive services supporting broadcast to the home with narrowband RC, a simple communication model consists of the following layers:

**Network dependent physical layer:** Where all the physical (electrical) transmission parameters are defined.

**Network dependent access mechanism layer:** Defines all the relevant data structures and communication protocols like data containers, etc.

**Network independent application layer:** Is the interactive application software and runtime environments (e.g. home shopping application, script interpreter, etc.).

DVB-RCC (ETS 300 800 [1]) addresses the lower two layers (the physical and transport) leaving the application layer open to competitive market forces.

A simplified model of the OSI layers was adopted to facilitate the production of specifications for these nodes. Figure 2 points out the lower layers of the simplified model and identifies some of the key parameters for the lower two layers. Following the user requirements for interactive services, no attempt will be made to consider higher medium layers in the present document.

#### Layer Structure for Generic System Reference Model

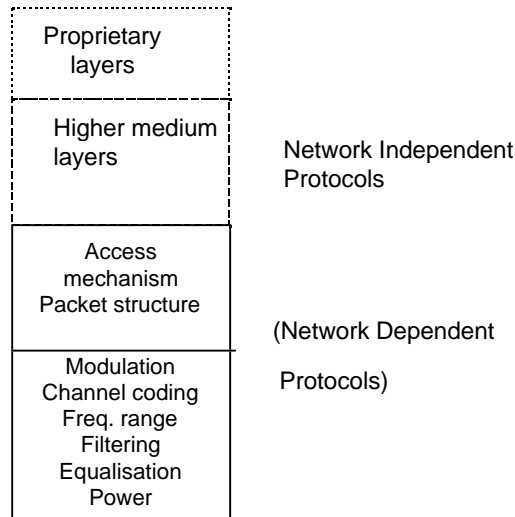

**Figure 2: Layer structure for generic system reference model**

The present document addresses the HFC/CATV network specific aspects only. The network independent protocols will be specified separately.

## 6 Specification outline

A multiple access scheme is defined in order to have different users share the same transmission media. Downstream information is sent broadcast to all users of the networks. Thus, an address assignment exists for each user which allows the INA to send information singlecast to one particular user. Two addresses are stored in Set Top Boxes (STB) in order to identify users on the network:

**MAC address:** It is a 48-bit value representing the unique MAC address of the NIU. This MAC address may be hard coded in the NIU or be provided by external source.

**NSAP address:** It is a 160-bit value representing a network address. This address is provided by higher layers during communication.

Upstream information may come from any user in the network and shall therefore also be differentiated at the INA using the set of addresses defined above.

This interactive system is based either on Out-Of-Band (OOB) or In-Band (IB) downstream signalling. However, STBs do not need to support both systems.

In the case of OOB signalling, a Forward Information Path (FIP) is added. The presence of this added FIP is in that case mandatory. However, it is also possible to send higher bit rate downstream information through a DVB-C channel whose frequency is indicated in the FIP.

In the case of IB signalling, the FIP is embedded into the MPEG2-TS of a DVB-C channel.

**NOTE:** It is not mandatory to include the FIP in all DVB-C channels.

Both systems can provide the same quality of service. However, the overall system architecture will differ between networks using IB STBs and OOB STBs. Both types of systems may exist on the same networks under the condition that different frequencies are used for each system.



Upstream and OOB downstream channels are divided into separate channels of 1 MHz or 2 MHz bandwidth for downstream and 1 MHz, 2 MHz or 200 kHz for upstream. Each downstream channel contains a synchronization frame used by up to 8 different UCs, whose frequencies are indicated by the Media Access Control (MAC) protocol.

Within UCs, users send packets with TDMA type access. This means that each channel is shared by many different users, who can either send packets with a possibility of collisions when this is allowed by the INA, or request transmission and use the packets assigned by the INA to each user specifically. Assuming each upstream path can therefore accommodate a large number of users at the same time, the upstream bandwidth can easily be used by all users present on the network at the same time.

The TDMA technique utilizes a slotting methodology which allows the transmit start times to be synchronized to a common clock source. Synchronizing the start times increases message throughput of this signalling channel since the message packets do not overlap during transmission. The period between sequential start times are identified as slots. Each slot is a point in time when a message packet can be transmitted over the signalling link.

The time reference for slot location is received via the downstream channels generated at the delivery system and received simultaneously by all STUs. This time reference is not sent in the same way for OOB and IB signalling. Since all NIUs reference the same time base, the slot times are aligned for all NIUs. However, since there is propagation delay in any transmission network, a time base ranging method accommodates deviation of transmission due to propagation delay.

Since the TDMA signalling link is used by NIUs that are engaged in interactive sessions, the number of available message slots on this channel is dependent on the number of simultaneous users. When messaging slots are not in use, a NIU may be assigned multiple message slots for increased messaging throughput. Additional slot assignments are provided to the NIU from the downstream signalling information flow.

There are different access modes for the upstream slots:

- reserved slots with fixed rate reservation (Fixed rate access: the user has a reservation of one or several time slots in each frame enabling, e.g. for voice, audio.);
- reserved slots with dynamic reservation (Reservation access: the user sends control information announcing his demand for transmission capacity. He gets grants for the use of slots.);
- contention based slots (These slots are accessible for every user. Collision is possible and solved by a contention resolution protocol.);
- ranging slots (These slots are used upstream to measure and adjust the time delay and the power.).

These slots may be mixed on a single carrier to enable different services on one carrier only. If one carrier is assigned to one specific service, only those slot types will be used which are needed for this service. Therefore, a terminal can be simplified to respond to only those slot types assigned to the service.

## 6.1 Bit rates and framing

For the interactive downstream OOB channel, a rate of 1,544 Mbit/s or 3,088 Mbit/s may be used. For downstream IB channels, no other constraints than those specified in DVB-C (EN 300 429 [2]) exist, but a guideline would be to use rates multiples of 8 kbit/s.

Downstream OOB channels continuously transmit a frame based on T1 type framing, in which some information is provided for synchronization of upstream slots. Downstream IB channels transmit some MPEG2-TS packets with a specific PID for synchronization of upstream slots (at least one packet containing synchronization information shall be sent in every period of 3 ms).

For upstream transmission, the INA can indicate three types of transmission rates to users, specifically 3,088 Mbit/s, 1,544 Mbit/s or 256 kbit/s. The INA is responsible of indicating which rate may be used by NIUs. It would imply all NIUs to be able to either transmit with 256 kbit/s, 1,544 Mbit/s, or 3,088 Mbit/s. Only the implementation of one of these bit rates would be mandatory.

Upstream framing consists of packets of 512 bits (256 symbols) which are sent in a bursty mode from the different users present on the network. The upstream slot rates are:

- 6 000 upstream slots/s when the upstream data rate is 3,088 Mbit/s;
- 3 000 upstream slots/s when the upstream data rate is 1,544 Mbit/s; and
- 500 upstream slots/s when the upstream data rate is 256 kbit/s.

## 6.2 Lower physical layer specification

In this subclause, detailed information is given on the lower physical layer specification. Figures 3, 4, 5, and 6 show the conceptual block diagrams for implementation.

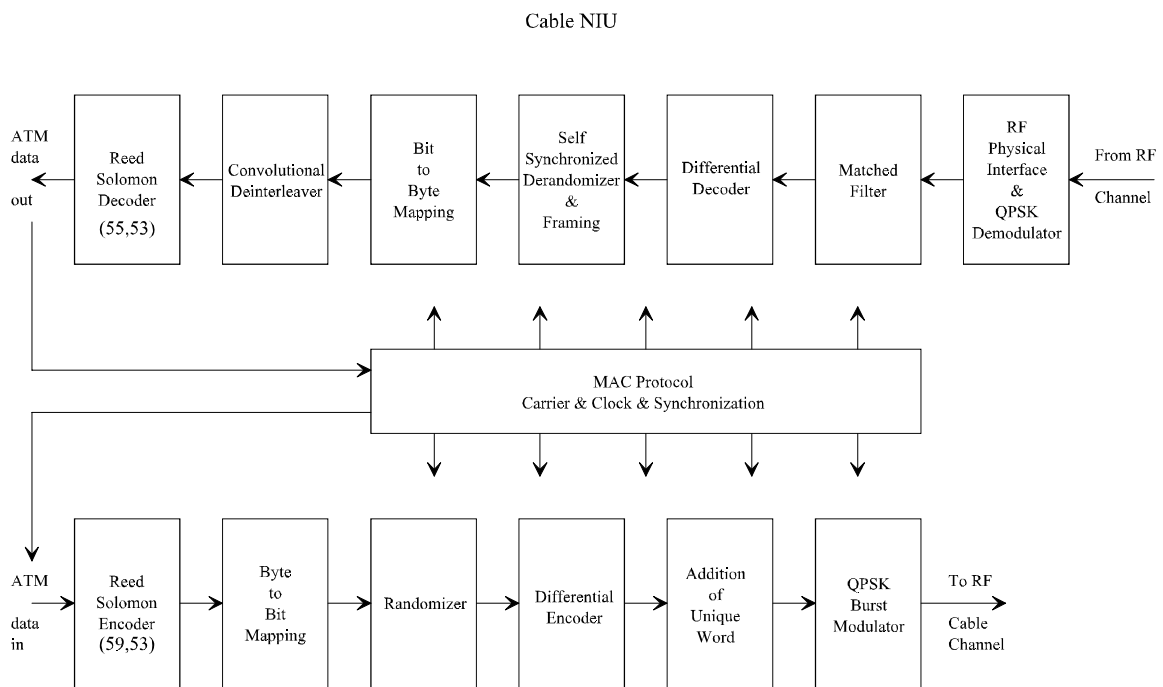

**Figure 3: Conceptual block diagram for the NIU OOB transceiver**

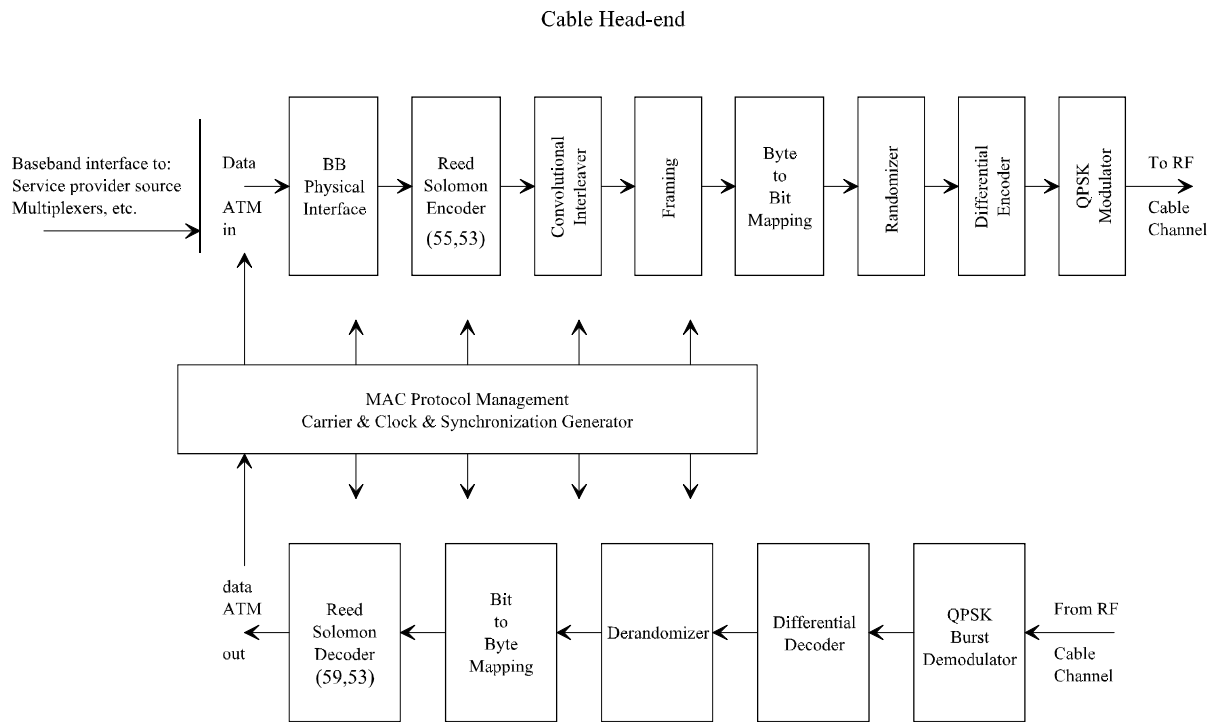

**Figure 4: Conceptual block diagram for the OOB head-end transceiver**

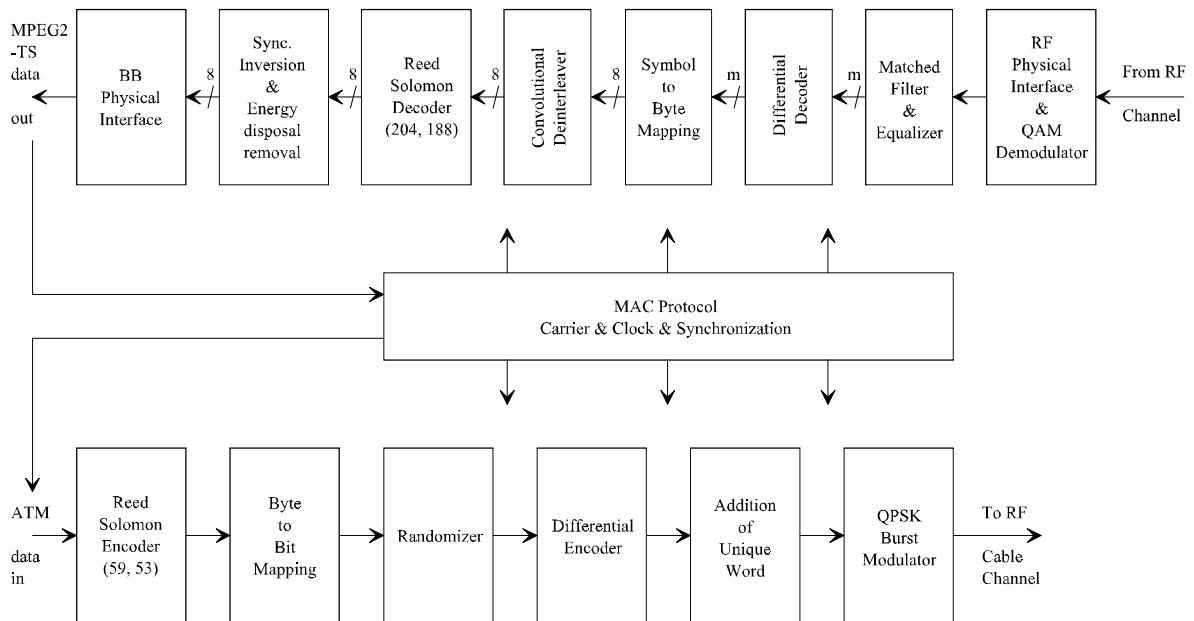

**Figure 5: Conceptual block diagram for the IB NIU transceiver**

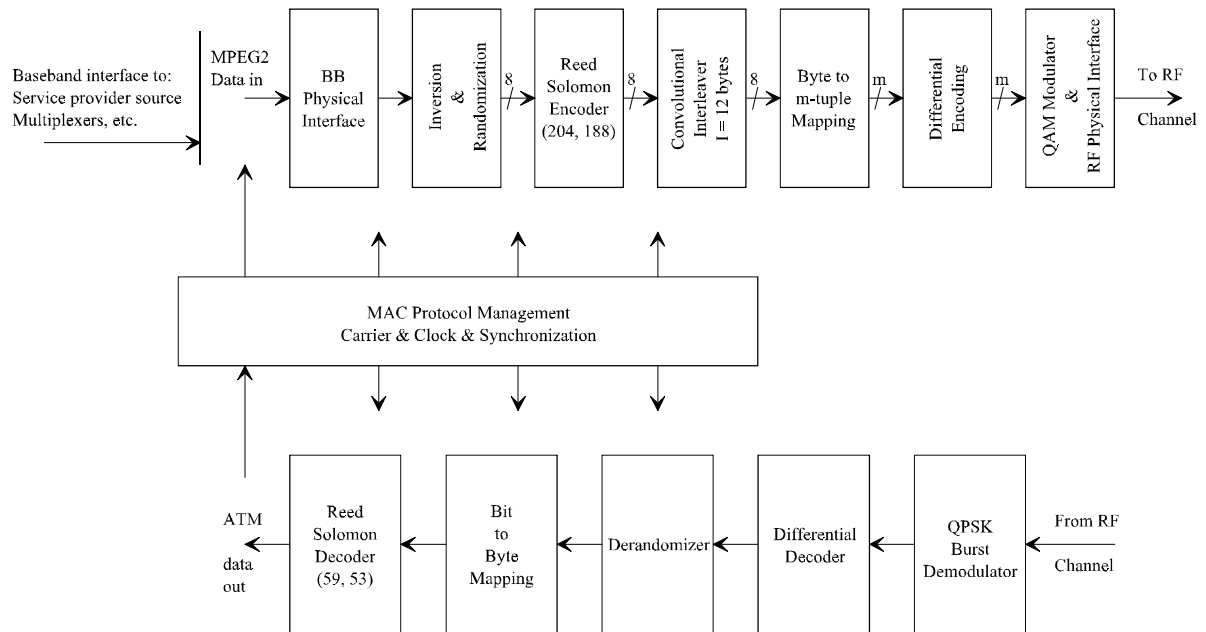

**Figure 6: Conceptual block diagram for the IB head-end transceiver**

## 6.3 MAC layer specification

### 6.3.1 MAC reference model

This subclause is limited to the definition and specification of the MAC layer protocol. The detailed operations within the MAC layer are hidden from the above layers.

This subclause focuses on the required message flows between the INA and the NIU for MAC. These areas are divided into three categories:

- Initialization, Provisioning and Sign-On Management,
- Connection Management and
- Link Management.

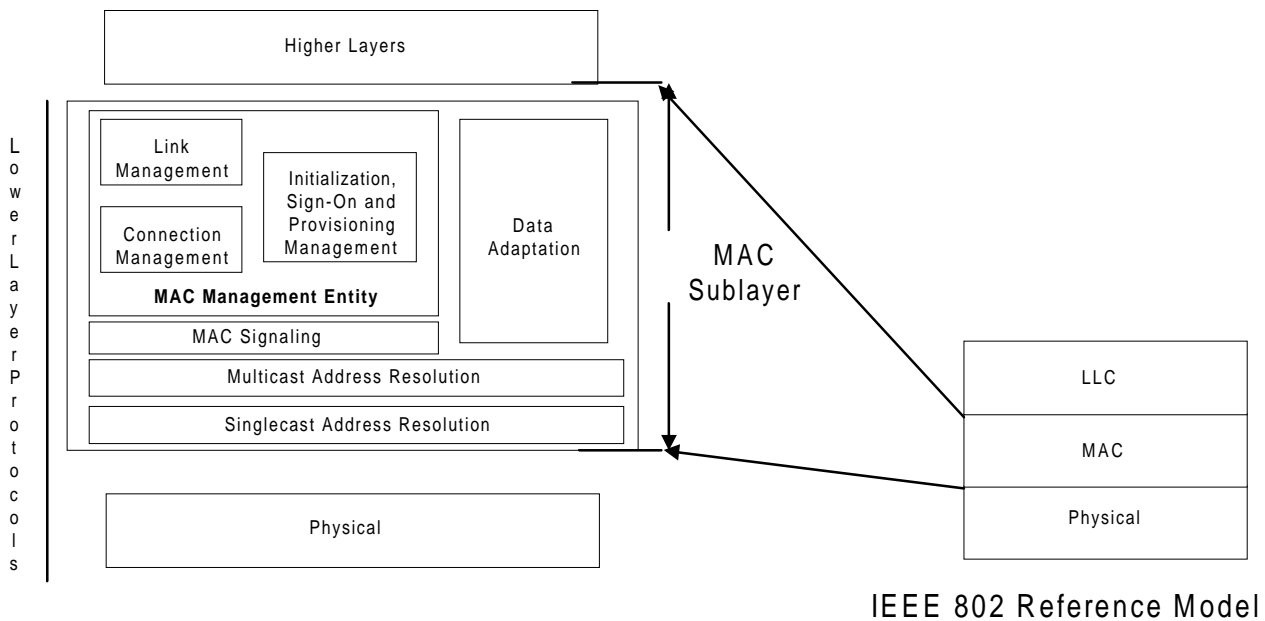

**Figure 7: MAC reference model**

### 6.3.2 MAC concept

Up to 8 QPSK UCs can be related to each downstream channel which is designated as a MAC control channel. An example of frequency allocation is shown in the figure 8. This relationship consists of the following items:

- 1) each of these related UCs share a common slot position. This reference is based on 1 ms time markers that are derived via information transmitted via the downstream MAC control channel;
- 2) each of these related UCs derive slot numbers from information provided in the downstream MAC control channel;
- 3) the messaging needed to perform MAC functions for each of these related UCs is transmitted via the downstream MAC control channel.

The MAC protocol supports multiple downstream channels. In instances where multiple channels are used, the INA shall specify a single OOB frequency called the provisioning channel, where NIUs perform initialization and provisioning functions. If both 1,544 Mbit/s and 3,088 Mbit/s downstream OOB channels coexist on the network, there should be one provisioning channel with each rate. Also, in networks where IB NIUs exist, provisioning should be included in at least one IB channel. An aperiodic message is sent on each downstream control channel which points to the downstream provisioning channel. In instances where only a single frequency is in use, the INA shall utilize that frequency for initialization and provisioning functions.

The MAC protocol supports multiple UCs. One of the UCs shall be designated the service channel. The service channel shall be used by NIUs entering the network via the initialization and provisioning procedure. The remaining UCs shall be used for upstream data transmission. In cases where only one UC is utilized, the functions of the service channel shall reside in conjunction with regular upstream data transmission.

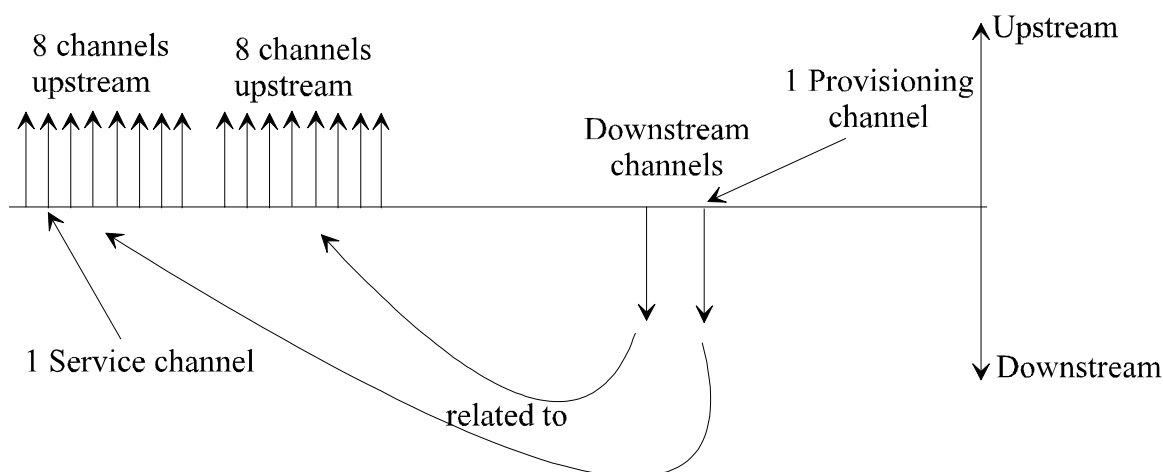

Figure 8: Example of frequency allocation

### 6.3.3 MAC messages

The MAC message types are divided into the logical MAC states of initialization, sign-on, connection management and link management. Messages in italic represent upstream transmission from NIU to INA. MAC messages are sent using broadcast or singlecast addressing. Singlecast address shall utilize the 48-bit MAC address.

Table 1: MAC messages

Message Type Value		Addressing Type
	<b>MAC Initialization, Provisioning and Sign-On Message</b>	
0x01	Provisioning Channel Message	Broadcast
0x02	Default Configuration Message	Broadcast
0x03	Sign-On Request Message	Broadcast
0x04	<i>Sign-On Response Message</i>	Singlecast
0x05	Ranging and Power Calibration Message	Singlecast
0x06	<i>Ranging and Power Calibration Response Message</i>	Singlecast
0x07	Initialization Complete Message	Singlecast
0x08-0x1F	[Reserved]	
	<b>MAC Connection Establishment and Termination Messages</b>	
0x20	Connect Message	Singlecast
0x21	<i>Connect Response Message</i>	Singlecast
0x22	<i>Reservation Request Message</i>	Singlecast
0x23	<i>Reservation Response Message (unused in the present version)</i>	Broadcast
0x24	Connect Confirm Message	Singlecast
0x25	Release Message	Singlecast
0x26	<i>Release Response Message</i>	Singlecast
0x28	Reservation Grant Message	Broadcast
0x29	Reservation ID Assignment	Singlecast
0x2A	<i>Reservation Status Request</i>	Singlecast
0x2B-0x3F	[Reserved]	
	<b>MAC Link Management Messages</b>	
0x27	Idle Message	Singlecast
0x40	Transmission Control Message	Scast or Bcast
0x41	Reprovision Message	Singlecast
0x42	Link Management Response Message	Singlecast
0x43	Status Request Message	Singlecast
0x44	Status Response Message	Singlecast
0x45-0x5F	[Reserved]	

To support the delivery of MAC related information to and from the NIU, a dedicated virtual channel shall be utilized. The Virtual Path Identifier (VPI), Virtual Channel Identifier (VCI) for this channel shall be 0x000,0x0021.

Upstream MAC messages:

AAL5 (as specified in ITU-T Recommendation I.363 [3]) adaptation shall be used to encapsulate each MAC PDU in an ATM cell. Upstream MAC information should be single 40 bytes cell messages.

Downstream OOB MAC messages:

AAL5 (as specified in ITU-T Recommendation I.363 [3]) adaptation shall be used to encapsulate each MAC PDU in an ATM cell. Downstream OOB MAC information may be longer than 40 bytes.

Downstream IB MAC messages:

Downstream IB MAC information is limited to 120 bytes long messages (A procedure to be able to send longer messages is under definition by the DVB Project). No AAL5 layer is defined for MPEG2-TS cells.

## 7 Network architecture and services

The network architecture varies substantially from place to place. This is due to the age of the network, the history of the operator and the price of services. Most of the existing networks have a RC installed on both the fibre and the coaxial part, and the limiting part is usually the coaxial part. It is important to note however, that some networks are not yet interconnected and only local interactivity is possible at the present time. In order to connect interactive service providers to INAs, an area network should be installed between INAs. DVB-RCC (ETS 300 800 [1]) was therefore designed to have enough flexibility to accommodate all types of services on all types of networks having RC capabilities. However, flexibility is obtained by giving a certain number of tools which do not have to all be implemented, depending on the services that are to be offered on the networks. The following subclauses present different types of networks, services, and use of the tools provided.

### 7.1 Examples of services

The following list enumerates services that are already provided by DVB-C (EN 300 429 [2]) and the new services offered by DVB-RCC (ETS 300 800 [1]).

Digital broadcast services (DVB):

- broadcast of audio, video, and data via a distribution network. No interaction by the user.

Interactive broadcast services (DVB-RC):

- Responses appreciated in broadcast programs (votes, bids, games etc.)
- Pay TV, Pay per View, Near Video on Demand (NVoD)
- Home shopping
- Banking

TV based multimedia services:

- Video on demand (movies, news, feature film, adverts)
- Distant learning
- Home shopping
- Information retrieval
- Games

Other services (PC-based, not covered by the DVB Project, for information):

- Data communication
- Voice (telephony)
- Information retrieval
- Access to online services
- LAN emulation

## 7.2 Examples of networks with interactive services

Most of the HFC networks are constituted of a fibre part and a coaxial part. Figure 9 illustrates a typical HFC network configuration. The head-end delivers the signal to the Optical Node Unit (ONU), which then distributes the signal to other trunk amplifiers and finally to the coax part. The coax is then divided into several users. While the broadcasting is simply done from the head-end to all NIUs on the network, the upstream transmission is a multiplex of all NIUs signals. This multiplex is defined so that the bandwidth allocation is close to optimal, depending on the services requested by NIUs.

The relationship between figure 1 and figure 9 is mostly an implementation issue which depends on the network design. Clearly the INA can be put at different levels in the diagram of figure 9. The closer it is to the broadcast network interface, the more NIUs shall be supported by the INA. Due to the bandwidth limitation, the INAs should probably be installed closer to the NIUs and an interconnection area network should support the traffic between all INAs on the network connected to servers (interactive service providers). This area network is not shown in figure 9.

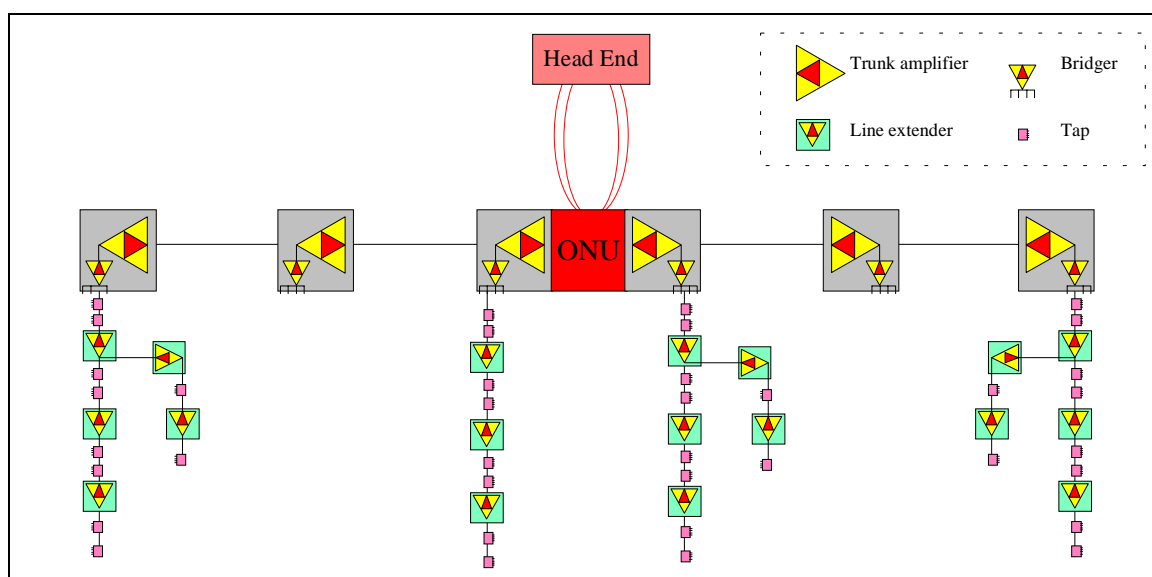

Figure 9: Typical HFC network

## 7.3 Possible links between servers and HFC networks

While HFC networks are nowadays constituted of separate head-ends with a broadcast distribution network connected to them for the purpose of broadcasting, they need to be interconnected to extend the capabilities of interactive services. Depending on the services that are going to be offered, different links can exist. For services such as Video on Demand (VoD) or data banks access, it is possible to connect an ATM network to the head-ends (this can use an existing SDH network). For Internet access, it is possible to be connected through an Ethernet or fast Ethernet connection. Finally, for telephony services, it may be better to be connected through a switch to the PSTN.

While the present document is typically designed to use an ATM protocol, it is not necessary to have an ATM network as the interconnection network. For instance, there can be simply one ATM node on the head-end side and several ATM nodes on the NIU sides, but the head-end can be connected to servers and other head-ends through any type of network as long as the INA is designed to interface between the HFC modem and the other network.

## 7.4 Frequency use

Figure 10 indicates a possible spectrum allocation. Although not mandatory, a guideline is provided to use the following preferred frequency ranges, 70 MHz - 130 MHz and/or 300 MHz - 862 MHz for the FIP (downstream OOB) and 5 MHz - 65 MHz for the RIP (upstream), or parts thereof. To avoid filtering problems in the bi-directional video amplifiers and in the STBs, the upper limit 65 MHz for the upstream flow shall not be used together with the lower limit 70 MHz for the downstream flow in the same system.



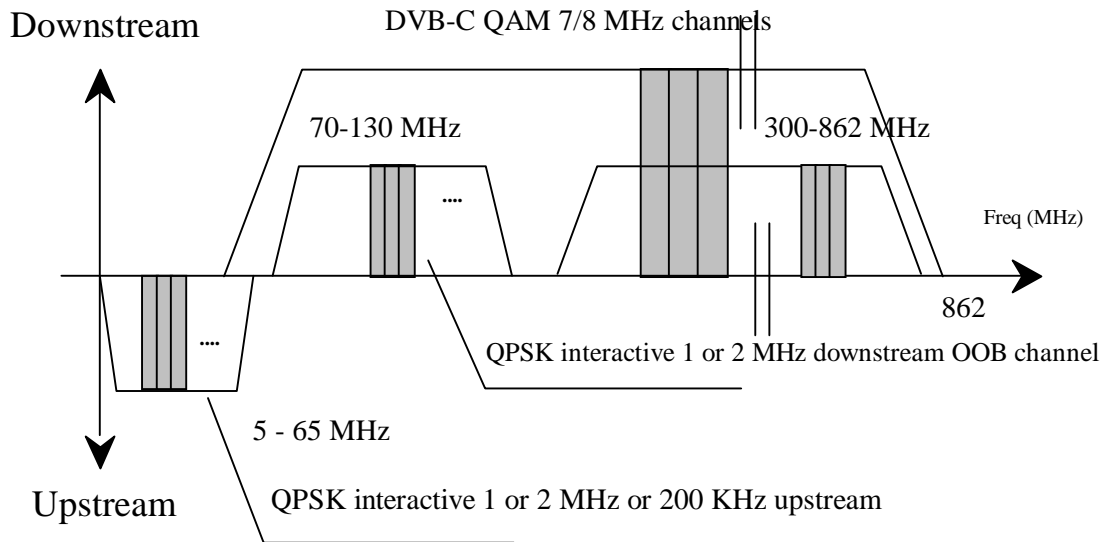

Figure 10: Preferred frequency ranges for CATV interactive systems

## 7.5 Impairments analysis

There are different types of impairments that exist on HFC networks. These impairments can be categorized into the following sections:

### Transfer function:

The transfer function depends on cables, amplifiers, filters, diplexers, that are located between the INA and the NIUs. A typical transfer function for an HFC network equipped with a RC between 5 MHz and 45 MHz is shown in the figures 11 and 12. Since the bandwidth used by the signal in ETS 300 800 [1] is relatively thin (200 kHz, 1 MHz or 2 MHz), the transfer function is flat enough so that no equalizer is required at the INA to compensate for amplitude variations, except perhaps in the highest part of the spectrum.

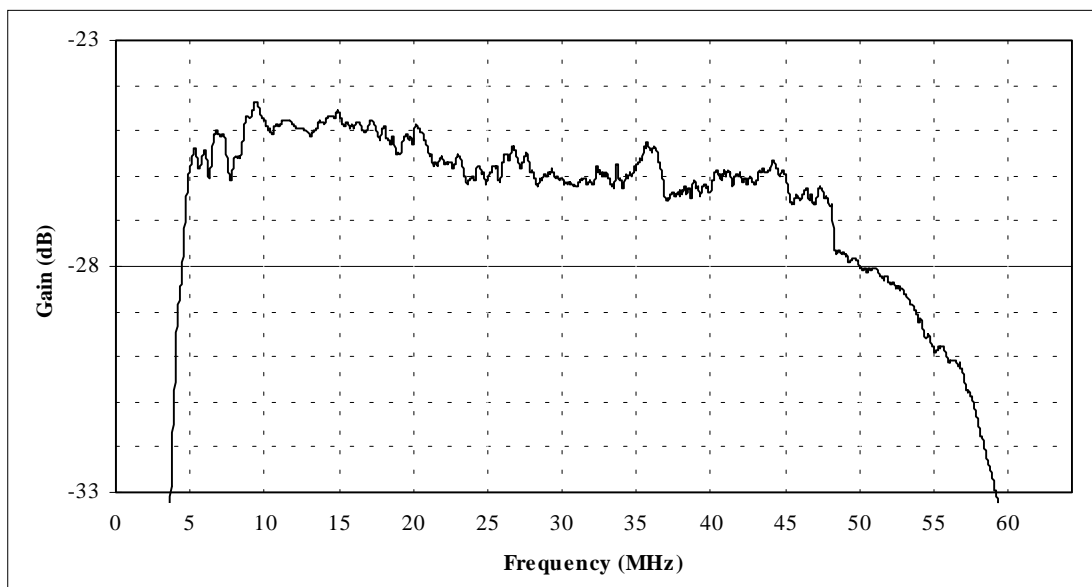
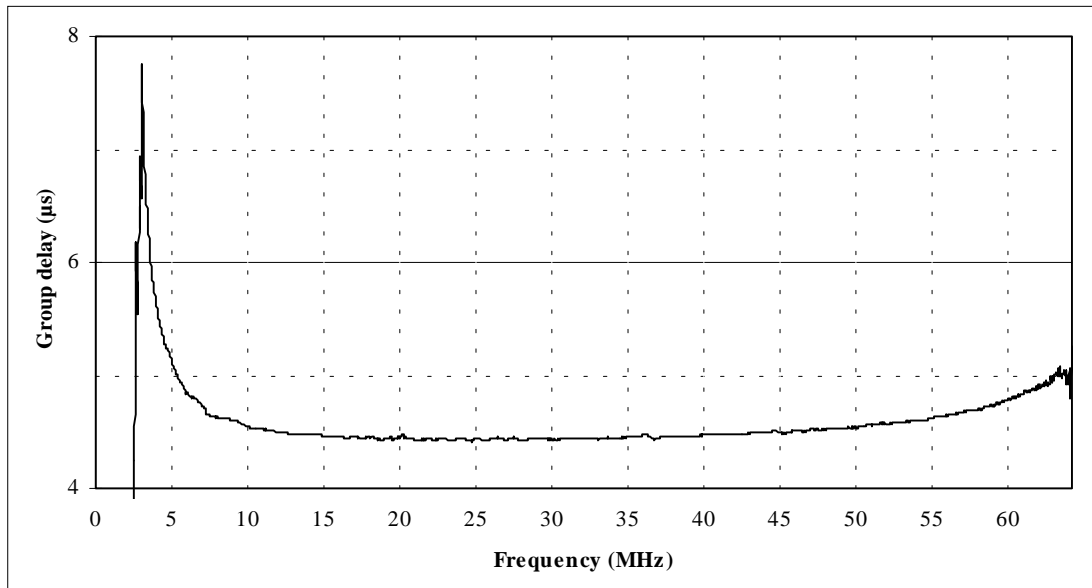

Figure 11: Typical return path gain

### Group delay:

The group delay is also dependent on the components installed on the network. Figure 12 shows the group delay for the same network as above.



**Figure 12: Typical return path group delay**

### Ingress noise:

Ingress noise is a narrowband interference that appears and disappears relatively slowly at different times of the day. The source can be anywhere in the network. It may be caused by temperature variations, CB radio transmitters, washing machines or dishwashers, and other radiating sources at the users premises. Different parameters characterize ingress noise, specifically the average duration of the noise, the frequency, and the level of the noise.

Figures 13, 14 and 15 show some measurements related to these parameters on typical HFC networks.

The present document offers three different types of bandwidth as well as frequency agility in order to avoid jammed frequencies. The lowest rate (256 kbit/s) is spread over a 200 kHz bandwidth, which is relatively thin in order to avoid narrowband interference. For the frequencies where low levels of noise occur, higher rates are provided over 1 MHz and 2 MHz bandwidth.

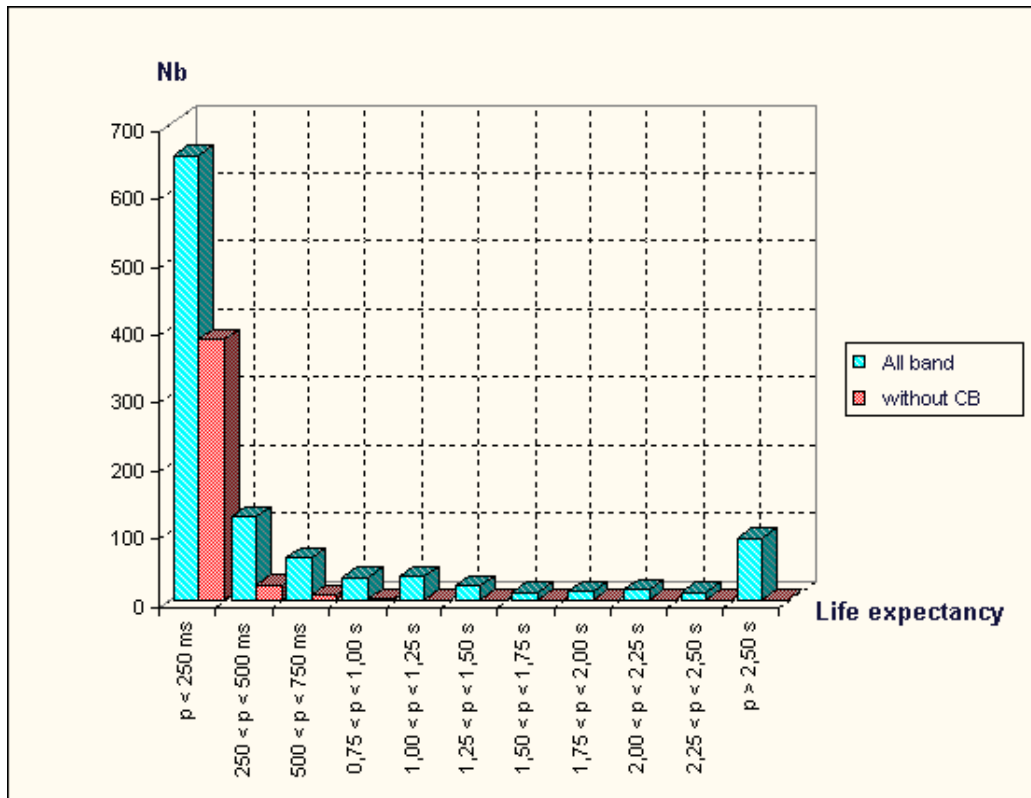

Figure 13: Life expectancy of ingress jammers taking into account the CB radio band or not

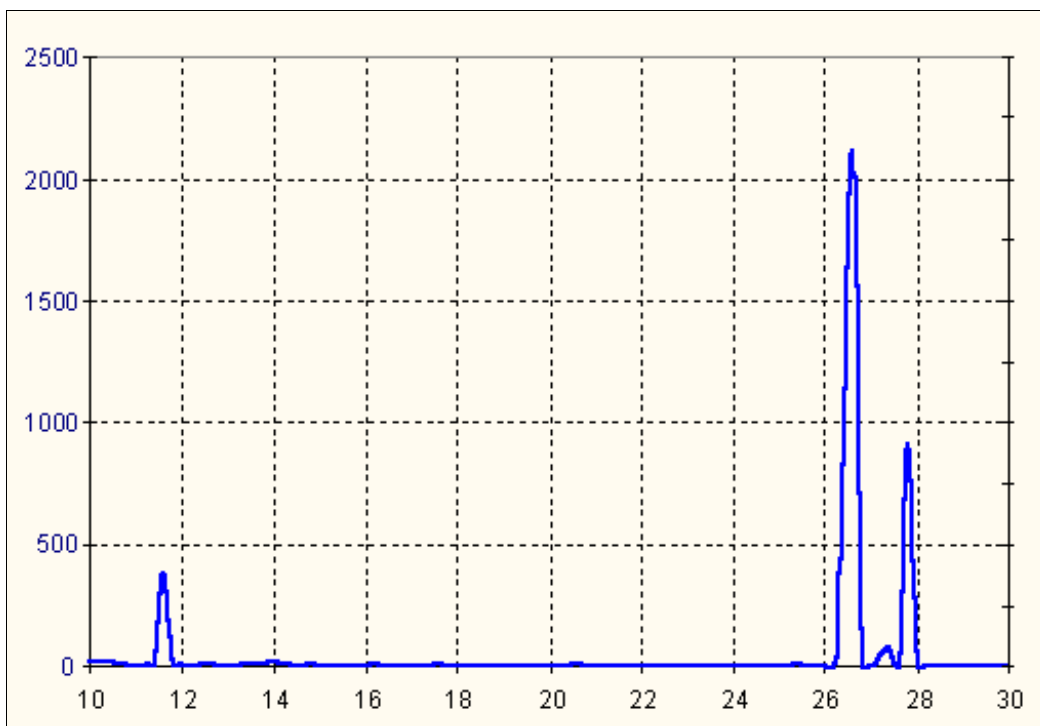

Figure 14: Number of ingress jammers recorded over a 40 hours period

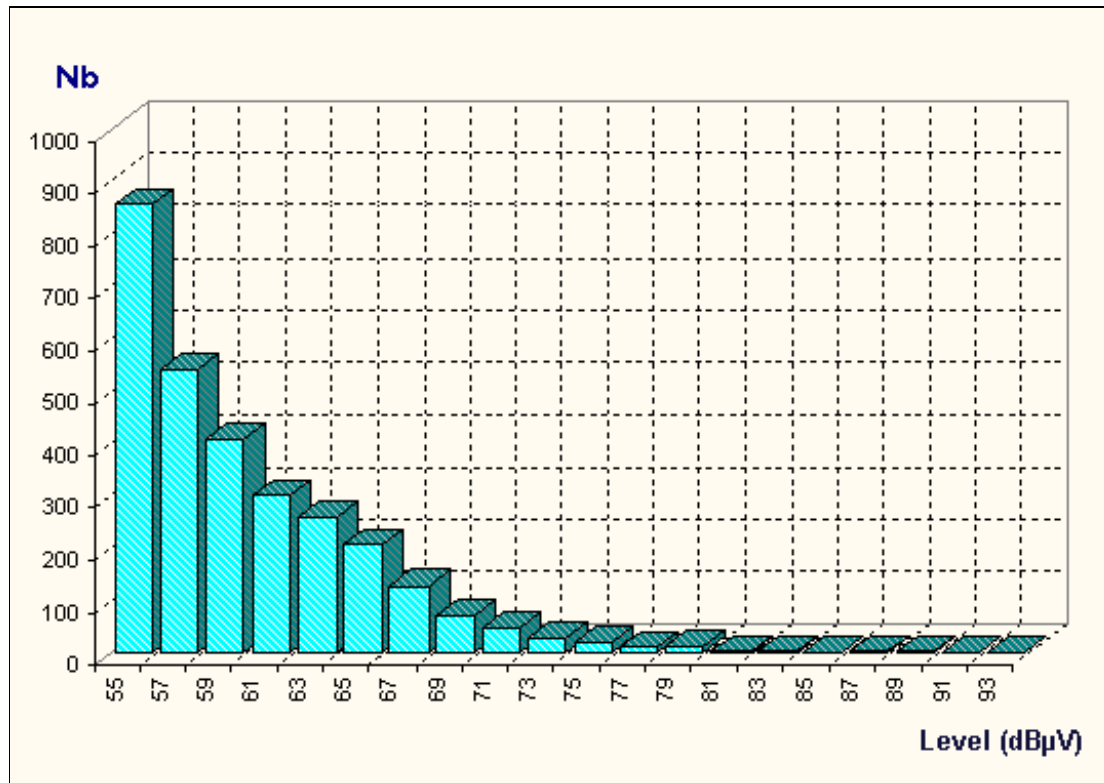

Figure 15: Number of ingress jammers occurrences at different levels

### Impulsive noise

Impulsive noise is characterized by short duration broadband jammers. They are caused by electric switches, lightning, and other short duration noise. No precise measurements are yet available, but it is important to note that the present document tolerates impulse noise of 3-byte long. This corresponds to approximately 94  $\mu$ s tolerance at the rate of 256 kbit/s, 15  $\mu$ s at the rate of 1,544 Mbit/s, and 8  $\mu$ s at the rate of 3,088 Mbit/s.

## 7.6 Dimensioning of networks

The dimensioning of networks depends strongly on the traffic that will be generated by the services offered to users. There are up to 65 536 slots available by TDMA cycle, that is 500 slots per second for 256 kbit/s, 3 000 slots/s for 1,544 Mbit/s, and 6 000 slots/s for 3,088 Mbit/s for each bandwidth that is shared between users. That means that if 30 MHz of bandwidth are used on the same network, around 90 000 slots are available per second. Figure 16 indicates the average rate offered to users as a function of the total number of users connected to the networks and assuming that at most 10 % of the slots are used for MAC processing and 30 % throughput is achieved for these messages due to collisions.

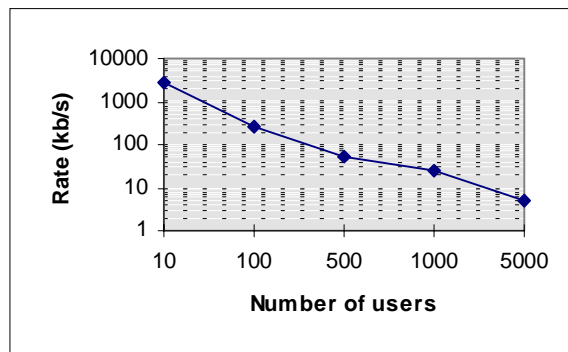

Figure 16: Estimated average rate per user as a function of the number of users connected.

Figure 16 indicates that if the entire bandwidth of 30 MHz is used, the ETS 300 800 [1] provides almost 10 kbit/s in average for each user even if 5 000 users are all connected to the same INA. More than 5 000 users can be connected if separate head-ends are used. This number corresponds to a single INA receiver.

---

## 8 Tools provided by the physical and MAC layer

### 8.1 Capabilities and grades of NIU

Different tools and capabilities are provided by DVB-C (ETS 300 800 [1]). These tools do not need to be all implemented in the NIUs of the network. Depending on the services and the cost related to both INAs and NIUs, the operator/manufacture may choose which option is best suited for its purposes/markets. The following subclauses describe the different tools and the grades provided by the present document along with the explanation of the advantages and disadvantages offered by each tool/grade.

#### a) Out-Of-Band (OOB) / In-Band (IB) principle

ETS 300 800 [1] is based either on OOB or IB downstream signalling. However, STBs do not need to support both systems.

In the case of OOB signalling, a FIP is added. This path is reserved for interactivity data and control information only. The presence of this added FIP is in that case mandatory. However, it is also possible to send higher bit rate downstream information through a DVB-C channel whose frequency is indicated in the FIP. The main advantage of the OOB solution is the possibility to dissociate broadcasting and interactive data on two separate channels, which offers the flexibility to the user to watch any program on TV while doing interactive processing independently (superimposed image, separate PC connected to the STB, telephony, etc.).

In the case of IB signalling, the FIP is embedded into the MPEG2-TS of a DVB-C channel. It is not mandatory to include the FIP in all DVB-C channels. The main advantage of the IB solution is to provide interactive data in the same channel as the broadcasting channel, thus providing a better link between the interactive session and the related broadcast program.

Both systems can provide the same quality of service. Yet, the overall system architecture will differ between networks using IB STBs and OOB STBs. Both types of systems may exist on the same networks under the condition that different frequencies are used for each system.

The main differences are the following:

For the STB: In the case of OOB signalling, a second tuner is needed and additional demodulation functions shall be included in the NIU. In the case of IB signalling, a MAC extracting function from the MPEG2-TS flow shall be included in the NIU.

For the INA: In the case of IB signalling, a MAC unit needs to be inserted between the MPEG2 multiplexers and the QAM modulators in order to add the MAC signalling into the MPEG2-TS flow. In the case of OOB signalling, a QPSK modulator is part of the INA.

#### b) Rate downstream and upstream

There are two rates provided for OOB downstream transmission corresponding to grade A of 1,544 Mbit/s and grade B of 3,088 Mbit/s.

In the case of IB downstream signalling (see EN 300 429 [2]).

There are three rates provided for upstream transmission corresponding to grade A of 256 kbit/s, grade B of 1,544 Mbit/s and grade C of 3,088 Mbit/s.

All combinations of the above grades upstream and downstream are allowed, but NIUs do not need to support all grades. NIUs shall support at least one grade upstream and downstream.

Grade A may be needed upstream for HFC networks with severe ingress noise, since it requires 200 kHz bandwidth only. The choice between 1,544 Mbit/s and 3,088 Mbit/s upstream or downstream is left to the manufacturer/operator.

### c) Number of simultaneous ATM virtual connections per NIU

For each connection provided by higher layers on the INA side (VPI/VCI), a connection ID is associated at the MAC layer. The maximum number of simultaneous connections that a NIU should support is defined as follows:

- Grade A: Only one connection at a time can be handled by a NIU. In that case, all connections shall be managed at higher medium layers, and should all use the same VPI/VCI value identified as default connection in the present document;
- Grade B: As many connections as needed, defined dynamically by the INA, following higher medium layers requests.

NOTE: Grade A can offer the same quality of service than grade B, assuming connections are managed at the application layer, but requires less hardware in the NIU for queuing ATM cells before transmission.

## 8.2 Upstream frequencies dynamic allocation

The allocation of upstream frequencies is managed by the INA. This means that the INA can use any measurement tool to figure out which frequency is better to use at any time and can decide to switch all users present on a given frequency at any time if this frequency is too jammed for a correct reception. MAC messages are provided for this purpose. However, the present document does not indicate how the level of interference should be measured, and what level of interference requires switching. This is left up to the manufacturer, since it does not affect interoperability.

## 8.3 Initialization and set-up

Initialization and set-up comprises two major functions. The first one is the connection to the network, the second one is the identification of the grade required. Obviously, if the connection is not made, the second function is not possible. The following algorithm summarizes what the first steps of a NIU connection are.

Lock up to the downstream control path (OOB or IB). If the operator wants to be as flexible as possible, both grades in the downstream OOB should be offered, in which case the NIU should first try to lock to its own fastest grade. Both IB and OOB can eventually be provided by the operator at the same time, in which case the NIU should refer to its own configuration to know which should be looked at first. However, the simplest solution is to impose a grade on all NIUs connected to the network such that only one type of modulators is used at the INA premises.

The downstream control information then contains further instructions on the grade to use downstream (MAC provisioning channel message). In the case where it is different from what the NIU selected by default, the NIU should change to the new frequency/grade and lock up to the new downstream frequency. On this frequency, further instructions are given on the upstream grade to use (MAC default configuration message).

The NIU shall then wait for the MAC Sign-On message from the INA before it tries to connect to the network. The INA will then go through the connection process one user at a time by sending a singlecast Ranging and Power Calibration message to the first NIU detected. This is absolutely necessary to avoid dead lock situations.

Once the NIU has gone through the whole sign-on and calibration procedure, it receives a default connection from the INA, and thus becomes a separate ATM node. The INA manages all bandwidth assignments, so it always controls the traffic on the network.

# 9 Connections management

The goal of the MAC protocol is to provide tools for higher medium layer protocols in order to transmit and receive data transparently and independently of the physical layer. Higher medium layer services are provided by the INA to the STU. The INA is thus responsible of indicating the transmission mode and rate to the NIU for each type of service. Specifically, for each connection provided by higher layers on the INA side (VPI/VCI), a connection ID is associated at the MAC layer (see subclause 8.1 (c) for more details).

However, bandwidth (time slots) does not need to be assigned immediately by the INA for a given connection. This means that a connection ID may exist at the NIU side without associated slot numbers.

The INA is responsible of providing transmission bandwidth to the NIUs when needed by higher layers. However, since the NIU shall transmit all data from the STU, the NIU is also responsible for requesting for more bandwidth if not already provided by the INA.

A default connection is initiated by the INA when STBs are first turned on. This connection can be used to send data from higher layers leading to further interactive connections. This connection can be associated to a zero transmission rate (no initial bandwidth allocation).

## 9.1 Connection protocol and bandwidth assignment

In the ATM world, connections are virtual, that is, they specify a node to node path without necessarily assigning bandwidth. Specifically, for the HFC RC, the concept is the same. When a user is connected, it means that it has received a default connection between the INA and the NIU. Further connections can then be requested using that particular connection and bandwidth can be requested following specific access modes.

Different access modes are provided to the NIUs within access regions specified by information contained in the slot boundary fields of the downstream superframes. The limits between access regions allow users to know when to send data on contention without risks of collision with contention-less type data. The following rules define how to select access modes:

Data connections:

When the INA assigns a connection ID to the NIU, it either specifies a slot list to be used (fixed rate access) or the NIU shall use contention or reserved access by following this algorithm:

- When the NIU shall send more cells than what was assigned by the INA, it can use contention access only if the number of cells to transmit is less than `Maximum_contention_access_message_length` (specified in the MAC Connect message from the INA). In that case, it shall wait for the slot reception indicator before it is allowed to send other cells with the same VPI/VCI value. The NIU can send one request for reservation access if the number of cells is less than `Maximum_reservation_access_message_length` (specified in the MAC Connect message from the INA). If more cells shall be transmitted, the NIU shall send multiple requests for reservation access.

MAC messages:

- MAC messages can be sent on contention access or reservation access. MAC messages sent upstream shall be less than 40-byte long. If the MAC information exceeds 40 bytes, it shall be segmented into multiple 40 bytes independent MAC messages. Ranging access can only be used for specific MAC messages.

### a) Contention access

Contention access indicates that data (MAC or bursty data traffic) is sent in the slots assigned to the contention access region in the UC. It can be used either to send MAC messages or data. The VPI, VCI of the ATM cells are then used to determine the type and direction of the data in higher layers. Contention based access provides instant channel allocation for the NIU.

The contention based technique is used for multiple subscribers that will have equal access to the signalling channel. It is probable that simultaneous transmissions will occur. For each ATM cell transmitted by the NIU, a positive acknowledgement is sent back by the INA, utilizing the reception indicator field, for each successfully received ATM cell. In contention based access mode, a positive acknowledgement indicates that a collision did not occur. A collision occurs if two or more NIUs attempt ATM cell transmission during the same slot. A collision will be assumed if a NIU does not receive a positive acknowledgement. If a collision occurs, then the NIU will retransmit using a procedure to be defined.

### b) Ranging access

Ranging access indicates that the data is sent in a slot preceded and followed by slots not used by other users. These slots allow users to adjust their clock depending on their distance to the INA such that their slots fall within the correct allocated time. They are either contention based when the ranging control slot indicator `b0` received during the previous superframe was 1 (or when `b1 to b6 = 55 to 63`), or reserved if the INA indicates to the NIU that a specific slot is reserved for ranging.

### c) Fixed rate access

NOTE: Fixed rate is called contention-less in DAVIC.

Fixed rate access indicates that data is sent in slots assigned to the fixed rate based access region in the UC. These slots are uniquely assigned to a connection by the INA. No fixed rate access can be initiated by the NIU.

### d) Reservation access

Reservation access implies that data is sent in the slots assigned to the reservation region in the UC. These slots are uniquely assigned on a frame by frame basis to a connection by the INA. This assignment is made at the request of the NIU for a given connection.

## 9.2 Interface between MAC and medium higher layers (ATM)

When a NIU is first turned on, it is not identified as a single ATM node, since no connection is possible without ranging and sign-on. The set of all users is thus seen as one single node at the ATM layer. The connection used to transmit MAC messages between the INA and the NIU is the same for all users, since it is viewed by the INA as one node. The MAC address used in the MAC messages thus identifies each user at the MAC layer, but not at the ATM layer. However, once the NIU is calibrated, it receives a first default connection from the INA which then identifies the user as a specific node at the ATM layer. From then on, the MAC layer becomes transparent to the ATM layer and messages can be sent from an ATM server to each user on the network as if they were separate ATM nodes.

NOTE: The default connection is not necessarily associated to a specific bandwidth, since bandwidth can be requested on demand.

## 9.3 Disconnection protocol

Different types of disconnection may occur. The following list describes each event and how the system shall be designed to recover from it.

- 1) Soft disconnection by NIU: This disconnection happens when the user makes a request to turn its STB off. In that case, each connection shall be turned off by the INA after a request from the user to the server at higher layers.
- 2) Hard disconnection by NIU (Power outage, plug fall, etc.): This disconnection happens by accident. In that case, the idle message which is supposed to be sent by each NIU periodically (around every 10 minutes) is not received by the INA. The INA then knows that the NIU is disconnected and considers all connections to be down. In the case where the STB recovers before these 10 minutes, it will try to start ranging again. If the INA receives requests for ranging from a NIU, it automatically considers the NIU as previously disconnected and considers all previous connections terminated.
- 3) Soft disconnection by INA: If the INA needs to receive maintenance, it first needs to stop all connections with each NIU.
- 4) Hard disconnection by INA: This could happen in case of a major alarm on the INA side. If the downstream stops, automatically all NIUs will reset since they do not receive control from the INA anymore. If the upstream burst demodulator stops, then the INA will send a soft disconnection or move the users to another frequency through the downstream control path. If the INA controller stops, then the NIUs will reset after a specific timeout at the higher layers.

# 10 Simulation of error performance and error handling

## 10.1 Error performance of the physical layer

This subclause describes the robustness of the physical layer of the DVB-RCC upstream signal. The return paths of current CATV networks are multi-point-to-point connections. Therefore a lot of unwanted signals disturb the upstream signal. The physical parameters of these signals can vary considerably. The combination of all of these disturbing signals is called ingress noise. The properties of the return paths are indicated by Signal-to-Noise power Ratios (SNRs).



To obtain such SNRs, both the signal power and the power of the ingress noise are calculated at the input of the INA. These calculations are based on the transmit power levels which are recommended by the DVB-RCC (ETS 300 800 [1]) as well as being derived by measurement results. The resulting SNRs correspond to particular slot-loss rates. The correlation between both was obtained by computer simulations.

### Signal power

The transmit power level of the STBs is given in ETS 300 800 [1]. The output level range is 85 - 122 dB $\mu$ V (RMS). Since the upper boundary of 122 dB $\mu$ V is very high for consumer STBs, the transmit power level of every individual STB should be reduced to the lowest possible value. However, for reasons of EMC, the value of 122 dB $\mu$ V shall not be exceeded. The upstream signals are attenuated by passive elements like cables and power splitters. The range of the transmission loss in existing cable networks depends of their size. It is between 20 dB and 65 dB. The combination of transmit power level and transmission loss results in an area of possible input levels at INA (see figure 17).

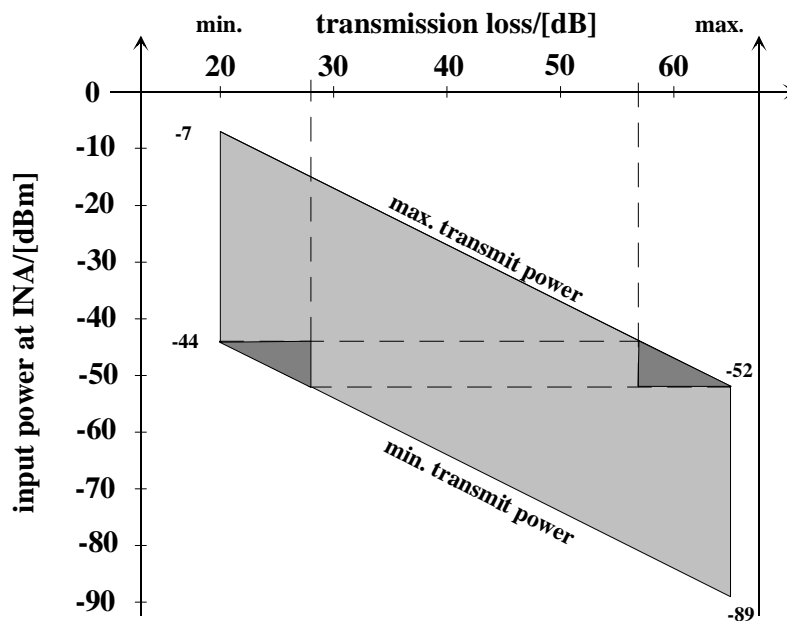

Figure 17: Possible power range at INA of the upstream signal

In large cable networks, in which, for example, the transmission loss covers the whole range of 45 dB (between 20 dB and 65 dB), the local head-end unit controls the STBs which are far away from the local head-end, so as to transmit at the maximum signal level. The received input power at INA is -52 dBm. If another STB which is very close to the local head-end (assumed transmission loss is minimal) transmits in the same return path as the first one, its level will be reduced by the control unit to obtain a constant input power. But the power level of the second STB cannot be reduced to below -44 dBm. Since the range of the transmission loss is greater than the control range of the STBs (as defined in the present document), the received power levels could differ by up to 8 dB. This discrepancy can be resolved by creating different network clusters. STBs which are not located in the same geographical area should not transmit in the same UC.

### Noise power

Measurements of ingress noise were carried out at different local head-ends of different real cable networks. Since the physical parameters of ingress noise (bandwidth, amplitude density, etc.) varies from case to case, the results are given as statistical mean values of all channels. The measured ingress noise power  $N$  does not exceed these values during some percentage of time. Therefore the corresponding SNRs are guaranteed during the same percentage of time.

Measurements show that some frequency ranges (e.g. 27 MHz) are very poor for upstream transmission. The network operator has the option to skip the worst channels and not to use them. When choosing 80 % of the whole upstream frequency range, the network operator is able to increase the statistical SNR performance by up to 3 dB. Table 2 shows an example of such measurement results. The filter used during the measurements had an equivalent noise bandwidth of 1 MHz.

**Table 2: Statistical evaluation of measured power levels of ingress noise at INA**

% of time	< 97	< 99	< 99,7	< 99,9	< 99,97
N / [dBm]	-64,3	-56,5	-50	-45,4	-41,7

### System behaviour

Simulation results of the upstream signal show that a SNR of about 12 dB is sufficient for the recommended slot-loss rate of  $10^{-6}$ . This means that if an SNR of 12 dB occurs at a given percentage of time, the recommended slot-loss rate will be guaranteed during this time. During the remaining time the slot-loss rate increases. However, if the SNR decreases to 11 dB, the slot-loss rate will be increased to about  $10^{-4}$ . Figure 18 shows an example of the system behaviour when using an upstream data rate of 1,544 Mbit/s. The system quality is expressed in probability of time at which the recommended slot-loss rate is less than  $10^{-6}$ . All STBs which are located at the end of the network (high transmission loss) are controlled by the local head-end, so as to transmit at maximum power level. In this example their signals will produce the adequate SNR of 12 dB at 97 % of the time. The probability increases when the transmission loss decreases. If the transmission loss is lower than 42 dB the transmit power levels of the corresponding STBs should be reduced. The recommended slot-loss rate of  $10^{-6}$  will be reached with a probability of more than 99,97 % of the time. The optimal transmit power-level curve is also given in this figure. The overall performance of the system, including all STBs which are connected to the network, depends on different parameters, which are: the mode of the used data rate (the performance of the system is better when using the mode in which 256 kbit/s are transmitted, but it is slightly worse using the 3,088 Mbit/s mode), the amounts of STBs and their individual transmission losses to the local head-end as well the quality of the cable network and, as a result of this, the effective ingress noise power.

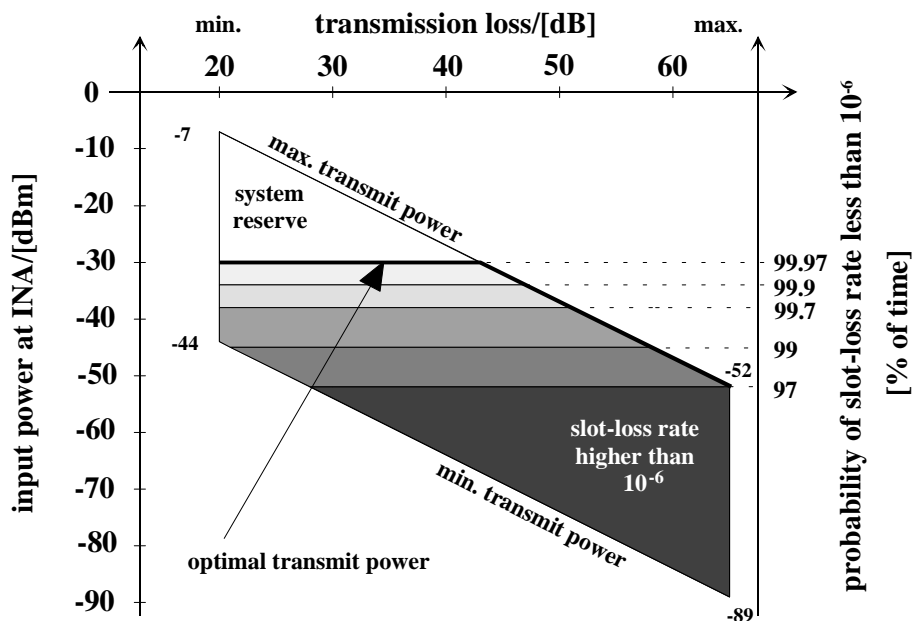

**Figure 18: Possible power range at INA of the upstream signal**

## 10.2 Traffic

Whereas traffic is difficult to estimate without knowing the user behaviour as a function of the services offered, it is important to note that traffic is entirely managed by the INA and different parameters are available to modify the amount of requests sent by users on contention or reservation. This provides a very useful tool to optimize the throughput over time depending on the traffic or number of users connected on the available bandwidth. These parameters are the following:

- access modes repartition using the slot boundary fields of the control path;
- ranging slot control using the slot boundary fields of the control path;
- reservation control using the slot boundary fields of the control path;
- access mode as a function of the size of queues indicated in the MAC Connect messages.

The algorithms used to optimize the traffic are left up to the manufacturers, since they do not affect interoperability.

## 10.3 Error handling

Error handling is required at the different layers depending on the location of transmission errors.

If errors occur during data transmission, higher layers such as Transmission Control Protocol (TCP) in the case of Internet Protocol (IP) packets transmission will request for retransmission. In that case, no error handling procedure is necessary at the physical or MAC layer, more exactly, error handling procedure shall not be implemented at the MAC layer, since it may lead to dead lock situations where the higher layer and the MAC layer both request for retransmission at the same time.

In the case of errors at the MAC layer, the situation is different. If a message that needs acknowledgement is incorrectly received, the acknowledgement will not happen and the message will have to be retransmitted. If the acknowledgement itself is not received, the INA will act as if the acknowledgement was not sent and will therefore reinitiate the whole MAC procedure.

In the case of collisions between packets coming from different users, the same applies. If a MAC message is sent and a collision occurs, then the MAC message shall be sent again. If a data message is sent on contention and a collision occurs, then no retransmission of that packet should be undertaken, or a dead lock situation may occur.

---

## History

<b>Document history</b>		
V1.1.1	December 1997	Publication