

Digital Video Broadcasting (DVB); Guidelines on implementation and usage of Service Information (SI)

European Broadcasting Union



Union Européenne de Radio-Télévision



Reference

RTR/JTC-DVB-161

Keywords

broadcasting, digital, DVB, MPEG, TV, video

ETSI

650 Route des Lucioles
F-06921 Sophia Antipolis Cedex - FRANCE

Tel.: +33 4 92 94 42 00 Fax: +33 4 93 65 47 16

Siret N° 348 623 562 00017 - NAF 742 C
Association à but non lucratif enregistrée à la
Sous-Préfecture de Grasse (06) N° 7803/88

Important notice

Individual copies of the present document can be downloaded from:

<http://www.etsi.org>

The present document may be made available in more than one electronic version or in print. In any case of existing or perceived difference in contents between such versions, the reference version is the Portable Document Format (PDF). In case of dispute, the reference shall be the printing on ETSI printers of the PDF version kept on a specific network drive within ETSI Secretariat.

Users of the present document should be aware that the document may be subject to revision or change of status. Information on the current status of this and other ETSI documents is available at

<http://portal.etsi.org/tb/status/status.asp>

If you find errors in the present document, send your comment to:

editor@etsi.org

Copyright Notification

No part may be reproduced except as authorized by written permission.
The copyright and the foregoing restriction extend to reproduction in all media.

© European Telecommunications Standards Institute 2004.

© European Broadcasting Union 2004.

All rights reserved.

DECT™, **PLUGTESTS™** and **UMTS™** are Trade Marks of ETSI registered for the benefit of its Members.
TIPHON™ and the **TIPHON logo** are Trade Marks currently being registered by ETSI for the benefit of its Members.
3GPP™ is a Trade Mark of ETSI registered for the benefit of its Members and of the 3GPP Organizational Partners.

Contents

Intellectual Property Rights	6
Foreword.....	6
1 Scope	7
2 References	7
3 Definitions and abbreviations.....	8
3.1 Definitions	8
3.2 Abbreviations	9
4 Rules of operation	11
4.1 Service Information (SI) table information	11
4.1.1 Network Information Table (NIT) information	12
4.1.2 Bouquet Association Table (BAT) information.....	13
4.1.3 Service Description Table (SDT) information.....	13
4.1.4 Event Information Table (EIT) information	14
4.1.4.1 EIT Present/Following information	14
4.1.4.2 EIT Schedule information	15
4.1.4.2.1 EIT Schedule structure	15
4.1.4.2.2 EIT scrambling	16
4.1.5 Time and Date Table (TDT)	16
4.1.6 Time Offset Table (TOT)	16
4.1.7 Running Status Table (RST).....	16
4.1.8 Stuffing Table (ST).....	17
4.1.9 Transport Stream Description Table (TSDT)	17
4.1.9.1 Digital Satellite News Gathering (DSNG)	17
4.1.10 Table update mechanism	17
4.2 SI descriptor allocation and usage.....	18
4.2.1 Descriptors of the Network Information Table (NIT).....	18
4.2.1.1 First descriptor loop	19
4.2.1.1.1 Linkage descriptor	19
4.2.1.1.2 Multilingual network name descriptor.....	19
4.2.1.1.3 Network name descriptor.....	19
4.2.1.1.4 Cell list descriptor.....	19
4.2.1.2 Second descriptor loop.....	20
4.2.1.2.1 Delivery system descriptors.....	20
4.2.1.2.2 Service list descriptor	20
4.2.1.2.3 Frequency list descriptor	20
4.2.1.2.4 Cell frequency link descriptor	20
4.2.2 Descriptors of the Bouquet Association Table (BAT).....	20
4.2.2.1 First descriptor loop	21
4.2.2.1.1 Bouquet name descriptor	21
4.2.2.1.2 CA identifier descriptor.....	21
4.2.2.1.3 Country availability descriptor	21
4.2.2.1.4 Linkage descriptor	21
4.2.2.1.5 Multilingual bouquet name descriptor.....	21
4.2.2.2 Second descriptor loop.....	22
4.2.2.2.1 Service list descriptor	22
4.2.3 Descriptors of the Service Description Table (SDT)	22
4.2.3.1 Announcement support descriptor	22
4.2.3.2 Bouquet name descriptor.....	22
4.2.3.3 CA identifier descriptor.....	22
4.2.3.4 Country availability descriptor.....	22
4.2.3.5 Data_broadcast_descriptor.....	23
4.2.3.6 Linkage descriptor.....	23
4.2.3.7 Mosaic descriptor.....	23
4.2.3.8 Multilingual service name descriptor	23

4.2.3.9	NVOD reference descriptor	23
4.2.3.10	Service descriptor	24
4.2.3.11	Service availability descriptor	24
4.2.3.11.1	Network Implementation Considerations (NIC)	24
4.2.3.11.2	IRD implementation considerations	25
4.2.3.12	Telephone descriptor	25
4.2.3.13	Time shifted service descriptor	25
4.2.4	Descriptors of the Event Information Table (EIT)	26
4.2.4.1	CA identifier descriptor	26
4.2.4.2	Component descriptor	26
4.2.4.3	Content descriptor	26
4.2.4.4	Data_broadcast_descriptor	26
4.2.4.5	Extended event descriptor	27
4.2.4.6	Linkage descriptor	27
4.2.4.7	Multilingual component descriptor	27
4.2.4.8	Parental rating descriptor	27
4.2.4.9	PDC descriptor	27
4.2.4.10	Short event descriptor	28
4.2.4.11	Telephone descriptor	28
4.2.4.12	Time shifted event descriptor	28
4.2.5	Descriptors of the Time Offset Table (TOT)	28
4.2.5.1	Local time offset descriptor	28
4.2.6	Descriptors of the Program Map Table (PMT)	29
4.2.6.1	AC-3 descriptor	29
4.2.6.2	Adaptation field data descriptor	29
4.2.6.3	Ancillary data descriptor	29
4.2.6.4	Data broadcast id descriptor	29
4.2.6.5	Mosaic descriptor	29
4.2.6.6	Service move descriptor	29
4.2.6.7	Stream identifier descriptor	30
4.2.6.8	Subtitling descriptor	30
4.2.6.9	Teletext descriptor	30
4.2.6.10	VBI data descriptor	30
4.2.6.11	VBI teletext descriptor	30
4.2.7	Other descriptors	30
4.2.7.1	Private data specifier descriptor	30
4.2.7.2	Stuffing descriptor	31
4.2.7.3	Data_broadcast_descriptor	31
4.2.7.4	Transport_stream_descriptor	31
4.2.8	ISO/IEC 13818-1 descriptors	31
4.2.9	Unknown descriptors	31
4.3	Program Specific Information (PSI) and DVB SI operational interaction states	32
4.4	Minimum repetition rates	32
4.4.1	Satellite and cable delivery systems	32
4.4.2	Terrestrial delivery systems	33
4.5	Terrestrial systems	33
4.5.1	Terms used within terrestrial systems	33
4.5.2	The use of alternative frequencies for multiplexes	35
4.5.3	Regional or local services	36
4.5.4	Hand-over	37
4.5.4.1	General description of the requirements	37
4.5.4.2	Hand-over by means of the frequency_list_descriptor	38
4.5.4.3	The occurrence of tuning failures	39
4.5.4.4	Hand-over methods with a reduced risk of tuning failures	40
4.5.4.4.1	Local SI insertion	40
4.5.4.4.2	Cell identification	41
4.5.4.4.3	Performance enhancement with GPS data	41
4.5.4.4.4	Two front-end solution	41
4.5.4.5	Performance considerations	41
4.5.4.6	Receiver guidelines	42
4.5.4.6.1	Hand-over by means of the frequency_list_descriptor	42
4.5.4.6.2	Hand-over by means of cell identification	43

4.5.4.6.3	Hand-over by means of cell description and GPS position	43
4.5.4.6.4	Hand-over with two-front-end solutions	44
4.5.4.7	Additional linkage modes	44
4.5.4.8	Additional remarks.....	44
4.6	Text string formatting.....	45
4.6.1	Use of control codes in names	45
4.6.2	Use of control codes in text	45
5	Applications	46
5.1	NVOD services	46
5.2	Mosaic services	48
5.2.1	General considerations.....	48
5.2.2	Relationship between mosaic service and SI/PSI Tables.....	49
5.3	Transitions at broadcast delivery media boundaries.....	50
5.3.1	Seamless transitions.....	50
5.3.2	Non-seamless transitions without re-multiplexing.....	51
5.3.3	Transitions with re-multiplexing.....	51
5.4	Announcements.....	51
6	Storage media.....	52
6.1	Program Association Table (PAT)	52
6.2	Program Map Table (PMT)	52
6.3	SI tables (NIT, SDT, EIT, BAT, RST, TDT, TOT)	52
6.4	Selection Information Table (SIT)	52
6.5	Discontinuity Information Table (DIT).....	53
Annex A:	Bibliography	54
History		55

Intellectual Property Rights

IPRs essential or potentially essential to the present document may have been declared to ETSI. The information pertaining to these essential IPRs, if any, is publicly available for **ETSI members and non-members**, and can be found in ETSI SR 000 314: *"Intellectual Property Rights (IPRs); Essential, or potentially Essential, IPRs notified to ETSI in respect of ETSI standards"*, which is available from the ETSI Secretariat. Latest updates are available on the ETSI Web server (<http://webapp.etsi.org/IPR/home.asp>).

Pursuant to the ETSI IPR Policy, no investigation, including IPR searches, has been carried out by ETSI. No guarantee can be given as to the existence of other IPRs not referenced in ETSI SR 000 314 (or the updates on the ETSI Web server) which are, or may be, or may become, essential to the present document.

Foreword

This Technical Report (TR) has been produced by Joint Technical Committee (JTC) Broadcast of the European Broadcasting Union (EBU), Comité Européen de Normalisation ELECTrotechnique (CENELEC) and the European Telecommunications Standards Institute (ETSI).

The present document is based on the DVB document TM1324, rev. 8/162 rev. 22, and it may be converted into a standard after market feedback. For this purpose, the wording of a standard (normative elements) rather than of a technical report (informative elements) has been used.

NOTE: The EBU/ETSI JTC Broadcast was established in 1990 to co-ordinate the drafting of standards in the specific field of broadcasting and related fields. Since 1995 the JTC Broadcast became a tripartite body by including in the Memorandum of Understanding also CENELEC, which is responsible for the standardization of radio and television receivers. The EBU is a professional association of broadcasting organizations whose work includes the co-ordination of its members' activities in the technical, legal, programme-making and programme-exchange domains. The EBU has active members in about 60 countries in the European broadcasting area; its headquarters is in Geneva.

European Broadcasting Union
CH-1218 GRAND SACONNEX (Geneva)
Switzerland
Tel: +41 22 717 21 11
Fax: +41 22 717 24 81

Founded in September 1993, the DVB Project is a market-led consortium of public and private sector organizations in the television industry. Its aim is to establish the framework for the introduction of MPEG-2 based digital television services. Now comprising over 200 organizations from more than 25 countries around the world, DVB fosters market-led systems, which meet the real needs, and economic circumstances, of the consumer electronics and the broadcast industry.

1 Scope

The present document provides implementation guidelines for the use and implementation of the DVB Service Information (SI) coding in a DVB digital TV environment including satellite- cable- and terrestrial networks.

The guidelines are intended to be highly recommended rules for the usage of the DVB SI syntax specified in EN 300 468 [1]. As such, they facilitate the efficient and reliable implementation of basic user-interaction functions in Integrated Receiver-Decoders (IRD).

The rules apply to broadcasters, network operators as well as manufacturers.

The rules are specified in the form of constraints on the DVB SI streams or in terms of intended interpretation by IRDs.

The specification of these functions in no way prohibits IRD manufacturers from including additional features, and should not be interpreted as stipulating any form of upper limit to the performance.

The guidelines do not cover features related to user-interface details or advanced Electronic Program Guides (EPG). Such issues are left to the marketplace.

NOTE: It is highly recommended that the IRD should be designed to allow for future compatible extensions to the DVB SI syntax. All the fields "reserved" (for ISO), "reserved_future_use" (for ETSI), and "user defined" in the EN 300 468 [1] should be ignored by IRDs designed not to make use of them. The "reserved" and "reserved_future_use" fields may be specified in the future by the respective bodies, whereas the "user defined" fields will not be standardized.

The present document uses the terminology defined in EN 300 468 [1] and should be read in conjunction with that EN.

2 References

For the purposes of this Technical Report (TR) the following references apply:

- [1] ETSI EN 300 468: "Digital Video Broadcasting (DVB); Specification for Service Information (SI) in DVB systems".
- [2] ISO/IEC 13818-1: "Information technology - Generic coding of moving pictures and associated audio information: Systems".
- [3] ETSI EN 300 472: "Digital Video Broadcasting (DVB); Specification for conveying ITU-R System B Teletext in DVB bitstreams".
- [4] ETSI TR 101 162: "Digital Video Broadcasting (DVB); Allocation of Service Information (SI) codes for DVB systems".
- [5] ETSI EN 301 192: "Digital Video Broadcasting (DVB); DVB specification for data broadcasting".
- [6] ETSI TR 101 202: "Digital Video Broadcasting (DVB); Implementation guidelines for Data Broadcasting".
- [7] ITU-R Recommendation BS.1196-1: "Audio coding for digital terrestrial television broadcasting" <http://www.itu.int/itudoc/gs/subscirc/itu-r/181e.rtf>

NOTE: ANNEX 2: "Digital Audio Compression (AC-3) Standard (ATSC Standard)", contains additional information on the AC-3 audio encoding algorithm and decoding requirements, relevant to this standard. Appendix 1 to Annex 2 of this Recommendation should be disregarded as it is not applicable to this technical report.

- [8] ETSI EN 300 744: "Digital Video Broadcasting (DVB); Framing structure, channel coding and modulation for digital terrestrial television".
- [9] ETSI TR 101 154: "Digital Video Broadcasting (DVB); Implementation guidelines for the use of MPEG-2 Systems, Video and Audio in satellite, cable and terrestrial broadcasting applications".

- [10] ETSI EN 301 775: "Digital Video Broadcasting (DVB); Specification for the carriage of Vertical Blanking Information (VBI) data in DVB bitstreams".
- [11] ETSI EN 301 210: "Digital Video Broadcasting (DVB); Framing structure, channel coding and modulation for Digital Satellite News Gathering (DSNG) and other contribution applications by satellite".
- [12] ETSI EN 300 231: "Television systems; Specification of the domestic video Programme Delivery Control system (PDC)".
- [13] ISO/IEC 13818-3: "Information technology - Generic coding of moving pictures and associated audio information - Part 3: Audio".
- [14] ISO/IEC 11172-3: "Information technology - Coding of moving pictures and associated audio for digital storage media at up to about 1,5 Mbit/s - Part 3: Audio".
- [15] ETSI EN 300 743: "Digital Video Broadcasting (DVB); Subtitling systems".
- [16] ETSI EN 300 401: "Radio Broadcasting Systems; Digital Audio Broadcasting (DAB) to mobile, portable and fixed receivers".
- [17] ETSI TS 102 006: "Digital Video Broadcasting (DVB); Specification for System Software Update in DVB Systems".
- [18] ISO/IEC 13818-2: "Information technology - Generic coding of moving pictures and associated audio information: Video".

3 Definitions and abbreviations

3.1 Definitions

For the purposes of the present document, the following terms and definitions apply:

AC-3: refers to the coding of audio using the Dolby AC-3 method (ITU-R Recommendation BS.1196-1 [7])

NOTE: The Service Information requirements for AC-3 streams carried in DVB systems is described in annex E of EN 300 468 [1]. The carriage of AC-3 elementary streams as private data within MPEG systems is described in annex C of TR 101 154 [9].

bouquet: collection of services marketed as a single entity

broadcaster (SERVICE Provider): organization which assembles a sequence of events or programmes to be delivered to the viewer based upon a schedule

component (ELEMENTARY Stream): one or more entities which together make up an event, e.g. video, audio, Teletext

cell: geographical area that is covered with DVB-T signals delivering one or more particular transport streams throughout the area by means of one or more transmitters

NOTE: The cell may in addition contain repeaters. Two neighbouring cells may be intersecting, or fully overlapping. The cell_id that is used to uniquely identify a cell shall be unique within each original_network_id. For hand-over purposes it is more convenient if the transport streams associated with the cell cover exactly the same area, or only one transport stream per cell is used.

Conditional Access (CA) system: system to control subscriber access to services, programmes and events
e.g. Videoguard, Eurocrypt

delivery system: physical medium by which one or more multiplexes are transmitted e.g. satellite system, wide-band coaxial cable, fibre optics, terrestrial channel of one emitting point

event: grouping of elementary broadcast data streams with a defined start and end time belonging to a common service, e.g. first half of a football match, News Flash, first part of an entertainment show

MPEG-2: Refers to the standard ISO/IEC 13818:

- Systems coding is defined in part 1 [2].
- Video coding is defined in part 2 [18].
- Audio coding is defined in part 3 [13].

multiplex: stream of all the digital data carrying one or more services within a single physical channel

network: collection of MPEG-2 TS multiplexes transmitted on a single delivery system, e.g. all digital channels on a specific cable system

section: syntactic structure used for mapping all service information into ISO/IEC 13818-1 [2]

NOTE: Transport Stream (TS) packets.

programme: concatenation of one or more events under the control of a broadcaster e.g. news show, entertainment show

service: sequence of programmes under the control of a broadcaster which can be broadcast as part of a schedule

Service Information (SI): digital data describing the delivery system, content and scheduling/timing of broadcast data streams, etc.

NOTE: It includes MPEG-2 Program Specific Information (PSI) together with independently defined extensions.

subcell: geographical area that is part of the cell's coverage area and that is covered with DVB-T signals by means of a transposer

NOTE: In conjunction with the cell_id the cell_id_extension is used to uniquely identify a subcell.

sub-table: comprised of a number of sections with the same value of table_id, table_id_extension and version_number

NOTE: The table_id_extension field is equivalent to the fourth and fifth byte of a section when the section_syntax_indicator is set to a value of "1".

table: comprised of a number of sections with the same value of table_id

Transport Stream (TS): data structure defined in ISO/IEC 13818-1 [2]

NOTE: It is the basis of the DVB standards.

3.2 Abbreviations

For the purposes of the present document, the following abbreviations apply:

AC-3	dolby AC-3 audio coding
ATSC	Advanced Television Systems Committee of the USA
BAT	Bouquet Association Table
CA	Conditional Access
DAB	Digital Audio Broadcasting
DIT	Discontinuity Information Table
DSNG	Digital Satellite News Gathering
DVB	Digital Video Broadcasting
DVD	Digital Versatile Disc
EIT	Event Information Table
EPG	Electronic Program Guide
ES	Elementary Stream
IRD	Integrated Receiver-Decoder
MFN	Multi-Frequency Network
MJD	Modified Julian Date
MPEG	Moving Pictures Expert Group
NIT	Network Information Table
NVOD	Near Video On Demand

PAT	Program Association Table
PID	Packet IDentifier
PMT	Program Map Table
PSI	Program Specific Information
QAM	Quadrature Amplitude Modulation
QPSK	Quadrature Phase Shift Keying
RST	Running Status Table
SDT	Service Description Table
SFN	Single Frequency Network
SHY	Soft HYphen
SI	Service Information
SIT	Selection Information Table
SMATV	Satellite Master Antenna TeleVision
ST	Stuffing Table
TDT	Time and Date Table
TOT	Time Offset Table
TPS	Transmission Parameter Signalling
TS	Transport Stream
TSDT	Transport Stream Description Table
UTC	Universal Time Coordinated
VPS	Video Programme System
WSS	Wide Screen Signalling

4 Rules of operation

This clause contains some recommendations on the usage of the Digital Video Broadcasting (DVB) Service Information (SI) syntax.

4.1 Service Information (SI) table information

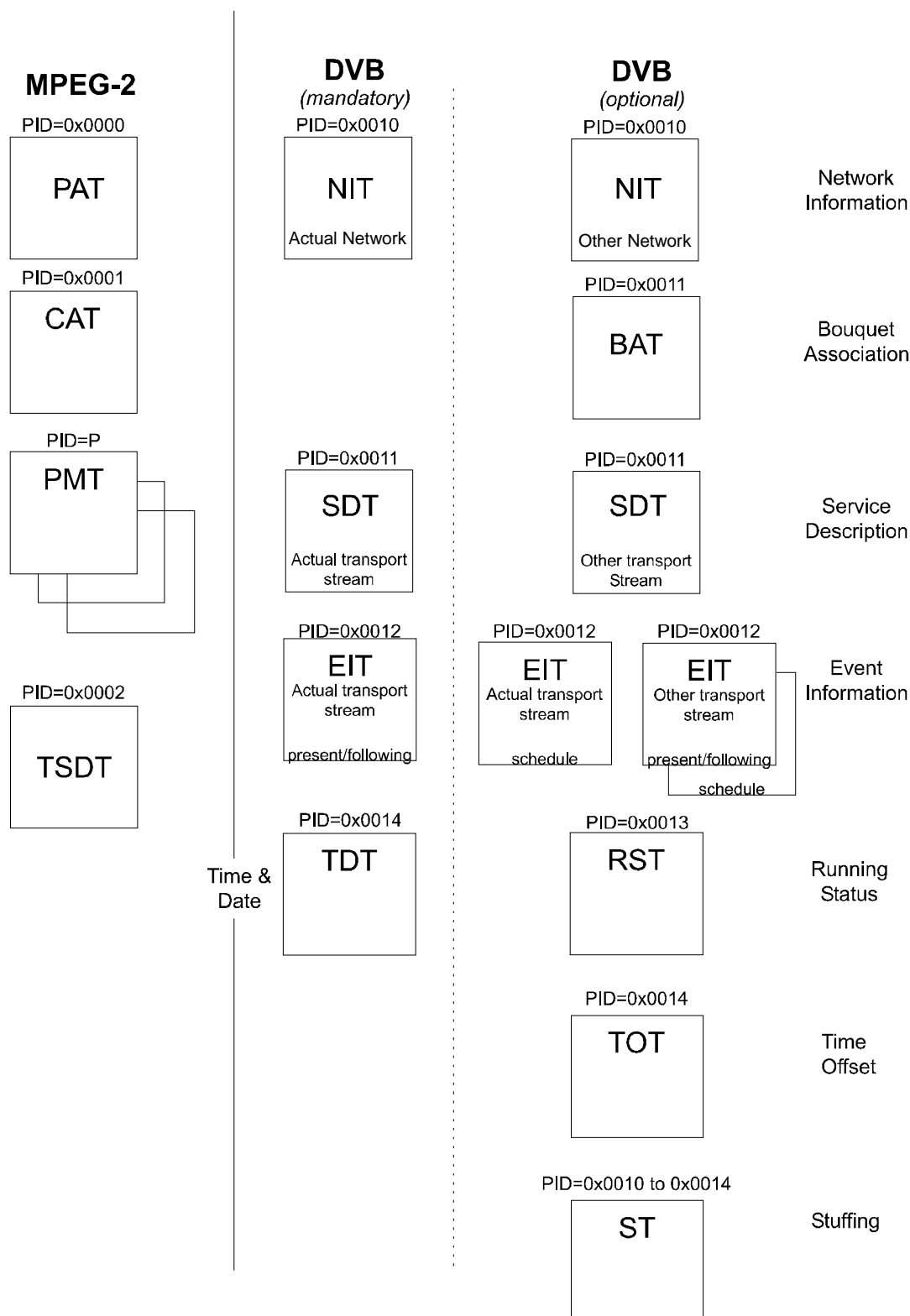

Figure 1: SI table information

4.1.1 Network Information Table (NIT) information

The Network Information Table (NIT) provides a grouping of Transport Streams (TSs) and the relevant tuning information. The NIT could be used during set-up procedures of the IRD and the relevant tuning information may be stored in non-volatile memory. The NIT also could be used to signal changes of tuning information. The following rules apply to the NIT:

- a) transmission of the NIT is mandatory for the actual delivery system;
- b) the NIT describing the actual delivery system is valid if and only if it contains applicable delivery system descriptors for the actual delivery system. This rule specifies the conditions under which the NIT contains valid information. At some transitions of broadcast delivery system boundaries, the NIT carried in a TS is allowed to describe an earlier network in the broadcast chain. A different mechanism has to be selected by the IRD to obtain the relevant tuning information for the actual delivery system. If a satellite IRD receives a satellite delivery system descriptor for the actual delivery system, then it is valid. If a cable IRD receives a cable delivery system descriptor for the actual delivery system, then it is valid. If a cable IRD receives a satellite delivery system descriptor for the actual delivery system, then it is assumed to be invalid for the cable IRD;
- c) if a valid NIT for the actual delivery system is present in the SI bit stream then it shall list all TSs of the actual delivery system;
- d) the SI stream shall have at least 8 TS packets per 10 s carrying NIT data or NULL packets. This rule simplifies the replacement of the NIT at broadcast delivery system boundaries. With the simple replacement mechanism, local frequency control is possible with relatively low cost equipment.

The SI uses two labels related to the concept of a delivery system, namely the `network_id` and the `original_network_id`. The latter is intended to support the unique identification of a service, contained in a TS, even if that TS has been transferred to another delivery system than the delivery system where it originated. A TS can be uniquely referenced through the path `original_network_id/transport_stream_id`.

A service can be uniquely referenced through the path `original_network_id/transport_stream_id/service_id`. The `network_id`, thus, is not part of this path.

In addition each `service_id` shall be unique within each `original_network_id`. When a service (contained inside a TS) is transferred to another delivery system, only the `network_id` changes, whereas the `original_network_id` remains unaffected.

By way of example, consider the following, where two services (A and B), which originate in two different delivery systems and happen to have the same `service_ids` and `transport_stream_ids`, are transferred to a new delivery system.

In the example, the two services are located on different TSs (X and Y) in the new network. If the two services were being combined onto the same TS, then it would be necessary to modify the identification of the services, since the same `service_id` value cannot be assigned to more than one service within a TS, and only one `original_network_id` can be associated with a TS (see clause 5.3 for further discussion on transitions at broadcast delivery media boundaries).

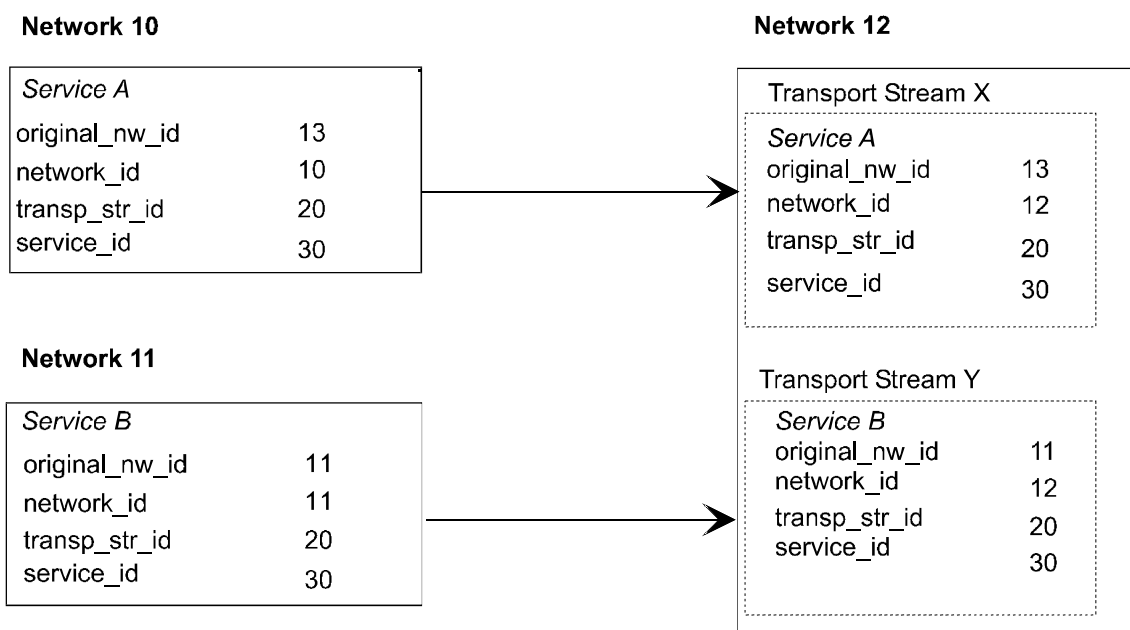

Figure 2: Transfer to a new delivery system

4.1.2 Bouquet Association Table (BAT) information

The BAT provides a grouping of services which serves as one basis on which an IRD presents the available services to a user. Transmission of the BAT is optional. The following rule improves the consistency in the SI bit streams and simplifies the processing in the IRDs.

The SI bit stream shall list in each BAT sub-table all the services belonging to that bouquet.

NOTE: One service may belong to more than one bouquet. This rule creates consistency across the different TSs which are accessible to the IRD.

If it is intended for the IRD to present service information to the user grouped in bouquets, then it would be beneficial to ensure that every service is listed in one or more bouquets, or some services will be omitted from this method of presentation. A bouquet may group together services from more than one TS, which could even be carried in different networks. The IRD's access to information on all the services of a bouquet would be facilitated if all the services referred to in the BAT were listed in the Service Description Table (SDT). Similarly, the IRD's access to these services is facilitated if NIT information is given for all TSs in which services of the bouquet occupy capacity.

4.1.3 Service Description Table (SDT) information

The SDT is used to list the names and other parameters of the services within TSs. For each TS a separate SDT sub-table exists. The following rules apply in order to improve the acquisition of services:

- the transmission of the SDT for the actual TS is mandatory;
- the SI bit stream shall list in the SDT of a particular TS at least all the services of that TS.

In addition:

- any SDT for another TS than the actual one (i.e. with table_id = 0x46) shall list all the services of that TS;
- it is strongly recommended that service_ids, once assigned to a specific service within a network, remain unchanged in order to enable IRDs to implement features like favourite channel lists, etc.

4.1.4 Event Information Table (EIT) information

The Event Information Table (EIT) is used to transmit information about present, following and further future events. For each service a separate EIT sub-table exists.

4.1.4.1 EIT Present/Following information

The following rule simplifies the acquisition of the EIT Present/Following information. The SI specification states that an EIT section has a maximum size of 4 096 bytes.

The SI bit stream shall have two sections per service for an EIT Present/Following with the section_number 0 x 00 reserved for the description of the present event and section_number 0x01 for the following event. These constraints do not apply in the case of an NVOD reference service which may have more than one event description per section, and may have more than two sections in the EIT Present/Following. It is recommended that the event descriptions be given in ascending order of event_id.

The SI bit stream shall have maximum of 4 096 bytes to describe a single event in a section.

The organization of the EIT Present/Following is based on the concept of present and following events. Which event is the present one can be determined using the following scheme:

- a) at each instant in time, there is at most one present event;
- b) when there is a present event, this event shall be described in section 0 of the EIT Present/Following;
- c) when there is no present event (e.g. in the case of a gap in the schedule) an empty section 0 of the EIT Present/Following shall be transmitted;
- d) the running_status field in the description of the present event shall be given the interpretation in table 1;

Table 1: running_status of the present event

undefined	No information except the nominal status is provided. IRDs and VCRs shall treat the present event as running.
running	IRDs and VCRs shall treat the present event as running.
not running	IRDs and VCRs shall treat the present event as not running. In other words, this event is nominally the present one, but at this time has either not started or already ended.
pausing	IRDs and VCRs shall treat the present event as pausing. In other words, this event is nominally the present one and has already started, but at this time the material being broadcast is not a part of the event itself. The transmission of event material shall resume at a later time.
starts in a few seconds	IRDs and VCRs shall prepare for the change of event status to "running" in a few seconds.

- e) at each point in time, there shall be at most one following event;
- f) if a following event exists, it shall be described in section 1 of the EIT Present/Following;
- g) if no following event exists, an empty section 1 of the EIT Present/Following shall be transmitted;
- h) the running_status field in the definition of the following event shall be given the following interpretation:

Table 2: running_status of the following event

undefined	No information except the nominal status is provided. IRDs and VCRs shall treat the following event as not running.
running	Not allowed.
not running	IRDs and VCRs shall treat the present event as not running.
pausing	This status is intended to indicate that the "following" event has been running at some time, but is now overlapped by another event. In such a case, during the whole time that the "following" event has status "pausing", one and the same overlapping event shall be encoded in section 0 of the EIT Present/Following. Furthermore, an event which has the status "pausing" shall acquire the status "running" at a later time, then replacing the overlapping event in section 0 of the EIT Present/Following.
starts in a few seconds	IRDs and VCRs shall prepare for the status of the following event to change to running within a few seconds.

The duration of an event as encoded in the field duration of the EIT shall also include the duration of all times when the event has the status "not running" or "paused". The start time of an event as encoded in the field start_time of the EIT shall be the start time of the entire event, i.e. not the start time after the pause has finished.

NOTE 1: The start time of one event plus its duration may be smaller than the start time of the following event. In other words, gaps between events are allowed. In such a case, the following event is considered to be the event scheduled to begin after the gap.
This event shall be encoded in section 1 of the EIT Present/Following.

NOTE 2: The start time and duration are scheduled times. Some broadcasters may update this information if the schedule is running late, whereas others may prefer to keep the indicated start time unchanged, e.g. to avoid having an event called "The News at 8" from being indicated as starting at 8:01:23, instead of 8:00:00.

4.1.4.2 EIT Schedule information

4.1.4.2.1 EIT Schedule structure

The EIT Schedule information is structured in such a way that it is easy to access the EIT data in a flexible manner. The EIT Schedule Tables shall obey the following rules:

- a) the EIT/Schedule is distributed over 16 table_ids, being 0x50 to 0x5F for the actual TS, and 0x60 to 0x6F for other TSs, which are ordered chronologically;
- b) the 256 sections under each sub-table are divided into 32 segments of 8 sections each. Segment #0, thus, comprises sections 0 to 7, segment #1 section 8 to 15, etc.;
- c) each segment contains information about events that start (see below) anywhere within a three-hour period;
- d) the information about separate events is ordered chronologically within segments;
- e) if only $n < 8$ sections of a segment are used, the information shall be placed in the first n sections of the segment. To signal that the last sections of the segment are not used, the value $s0 + n - 1$, where $s0$ is the first section number of the segment, shall be encoded in the field segment_last_section_number of the EIT header. As an example, if segment 2 contains only 2 sections, the field segment_last_section_number shall contain the value $8 + 2 - 1 = 9$ in those two sections;
- f) segments that contain all their sections shall have the value $s0 + 7$ encoded in the field segment_last_section_number;
- g) entirely empty segments shall be represented by an empty section, (i.e. a section which does not contain any loop over events) with the value $s0 + 0$ encoded in the field segment_last_section_number;
- h) the placing of events in segments is done referring to a time $t0$.
 $t0$ is "last midnight" in Universal Time Coordinated (UTC) time.
Suppose, for instance, that it is 5.00 PM in the time zone UTC-6. It is then 11.00 PM in the time zone UTC+0, which makes it 23 hours since "last midnight". Therefore, $t0$ is 6.00 PM the previous day in UTC-6;

- i) segment #0 of table_id 0x50 (0x60 for other TSs) shall contain information about events that start between midnight (UTC Time) and 02:59:59 (UTC Time) of "today". Segment #1 shall contain events that start between 03:00:00 and 05:59:59 UTC time, and so on. This means that the first sub-table (table_id 0x50, or 0x60 for other TSs) contains information about the first four days of schedule, starting today at midnight UTC time;
- j) the field last_section_number is used to indicate the end of the sub-table. Empty segments that fall outside the section range indicated by last_section_number shall not be represented by empty sections;
- k) the field last_table_id is used to indicate the end of the entire EIT/Schedule structure. Empty segments that fall outside the table_id range indicated by last_table_id shall not be represented by empty sections;
- l) segments that correspond to events in the past may be replaced by empty segments (see rule g));
- m) the running_status field of event definitions contained in the EIT/Schedule shall be set to undefined (0x00);
- n) EIT/Schedule tables are not applicable to NVOD Reference Services, since these have events with undefined start times.

4.1.4.2.2 EIT scrambling

The EIT Schedule Tables may be scrambled. In order to provide an association with the Conditional Access (CA) streams, it is necessary to allocate a service_id (= MPEG-2 program_number) which is used in the Program Specific Information (PSI) to describe scrambled EIT Schedule Tables.

The EIT is identified in the Program Map Table (PMT) section for this service_id as a programme consisting of one private stream, and this PMT section includes one or more CA_descriptors to identify the associated CA streams. The service_id value 0xFFFF is reserved in DVB applications for this purpose.

4.1.5 Time and Date Table (TDT)

The Time and Date Table (TDT) transmits the actual UTC-time coded as Modified Julian Date (MJD). It may be used to synchronize the internal clock of an IRD. The TDT shall be transmitted at least every 30 s. The encoded time is intended to be valid when the section becomes valid according to figure 3.

4.1.6 Time Offset Table (TOT)

The TOT transmits the actual UTC-time including also time offset information coded as MJD. It may be used to synchronize the internal clock of an IRD. Transmission of the TOT is optional, but if present it shall be transmitted at least every 30 seconds. The encoded time is intended to be valid when the section becomes valid according to figure 3.

4.1.7 Running Status Table (RST)

Running status sections are used to rapidly update the running status of one or more events. Running status sections are sent out only once, at the time the status of an event changes, unlike other SI Tables which are normally repetitively transmitted. Thus there does not exist any update mechanism for RSTs.

At the moment an RST is transmitted to update the running status of an event, it invalidates the running status of that event, transmitted previously by the EIT Present/Following. The following time the EIT is transmitted, it shall contain the updated running status bits.

The intended use of this optional mechanism is to enable IRDs or VCRs to implement highly accurate switching to the beginning of events by setting up a filter on Running Status Tables and waiting for the occurrence of the RST section containing the event.

4.1.8 Stuffing Table (ST)

A stuffing section may occur in anywhere that a section belonging to an SI Table is allowed. Stuffing Tables may be used to replace or invalidate either sub-tables or complete SI Tables. In order to guarantee consistency, all sections of a sub-table shall be stuffed. It is not allowed to replace some sections of a sub-table by stuffing some sections while keeping others.

4.1.9 Transport Stream Description Table (TSDT)

The transmission of the Transport Stream Description Table (TSDT) (ISO/IEC 13818-1 [2]) within DVB Transport Streams is optional but recommended. The decoding of the TSDT is optional. Decoders which are designed to support different MPEG based systems should be able to decode and interpret this table.

If the TSDT is present, at least one `transport_stream_descriptor` shall be present at the beginning of the descriptor loop. The compatibility of a transport stream with different MPEG-based systems shall be indicated by the presence of more than one `transport_stream_descriptor`.

If the Transport Stream is compatible with DVB, the following descriptors are allowed in the descriptor loop and shall appear after the `transport_stream_descriptor`:

- `linkage_descriptor`;
- `private_data_specifier_descriptor` followed by private descriptors; and
- `private_data_indicator_descriptor` (ISO/IEC 13818-1 [2]).

4.1.9.1 Digital Satellite News Gathering (DSNG)

For DSNG transmissions the Transport Stream Description Table (TSDT) shall be present in the bitstream. The TSDT descriptor loop shall contain the `transport_stream_descriptor` with the ASCII codes for "DSNG" in the text field.

At least one `DSNG_descriptor` shall be present in the TSDT. The semantics for the DSNG descriptor are defined in EN 301 210 [11].

In pure DSNG transmissions only the PAT, PMT and TSDT need to be present.

If compatibility with consumer IRDs is required, at least all mandatory SI-tables and descriptors shall be present in the bitstream and the first TSDT descriptor shall contain "DVB" while the second contains "DSNG".

4.1.10 Table update mechanism

The section syntax used in the DVB Service Information (SI) supports various signalling mechanisms for SI contents updates.

The update of a section will be signalled by incrementing the `version_number` field. The update will be effective immediately following the last byte of the `CRC_32` of the new version of the section, so the `current_next_indicator` shall always have the value of "1". Sections with `current_next_indicator` set to "0" are never transmitted.

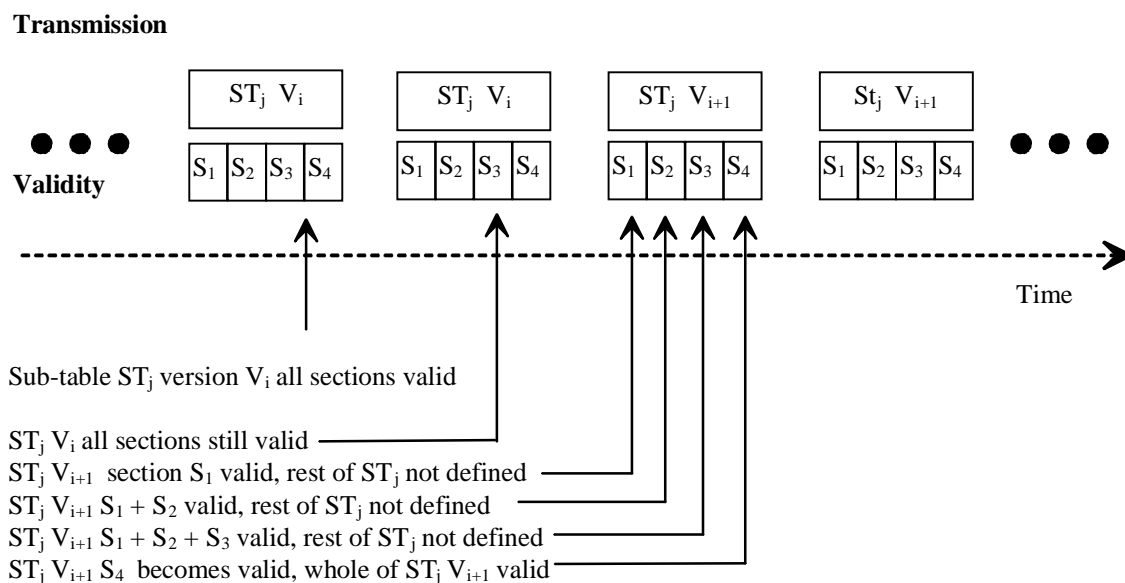

NOTE: Sections of a sub-table do not have to be transmitted in number order. Some IRD implementations may acquire data with improved efficiency if the sections of a sub-table are transmitted in numerical order. However, a broadcaster may not transmit the sections in order owing to random access considerations.

Figure 3: Timing of table updates and validity

4.2 SI descriptor allocation and usage

This clause specifies the location where descriptors can be expected in a SI bit stream, and identifies which descriptors may occur multiple times. Descriptors which contain fundamental SI data are identified as recommended to be decoded by the IRD. The interpretation of other descriptors by the IRD is optional.

4.2.1 Descriptors of the Network Information Table (NIT)

The NIT is organized as follows:

```

/* header ...*/
for i = 0; i < N; i++ { /* 1st descriptor loop */
    descriptor()
}
for ( i = 0; i < N; i++) {
    /* loop over Transport Streams */
    transport_stream_id
    original_network_id
    for ( j = 0; Ij < M; j++) { /* 2nd descriptor loop */
        descriptor()
    }
}
/* CRC etc. */

```

4.2.1.1 First descriptor loop

Only the DVB SI descriptors in this clause have a defined meaning in the first loop of the NIT.

4.2.1.1.1 Linkage descriptor

This descriptor is used to give a link to another service or TS. If it appears in this loop it links to a service that is attached to the network operator. This descriptor is allowed more than once in this loop, it could for example point to the "Paris Cable Info channel" and to "Paris Cable Text". Transmission of this descriptor is optional. The meaning of the descriptor when it occurs here depends on the value of the linkage_type. If the linkage_type is:

- a) 0x01, it refers to a service that contains information about the network. An example of the intended use is for the IRD to switch to the information service when the user requests additional information about the network;
- b) 0x02, it refers to an Electronic Program Guide (EPG) for the network. Note that the IRD can only make use of this type of linkage if it can decode the EPG service. This ETR does not specify the contents of such a service;
- c) 0x04, it refers to a TS which carries comprehensive Service Information. The SI carried in the referenced TS includes at least all the SI information available on all other TSs of the network;
- d) 0x08, it refers to a service in a terrestrial network to which the receiver might tune to if the actual service is no longer receivable under its service_id. Valid links for the actual service can be identified by the initial service id. The hand-over_type indicates whether the linkage_descriptor is used to link to an identical service in a neighbouring country, to a local variation of the service or an associated service;
- e) 0x09, it refers to a transport stream carrying a System Software Update service, see TS 102 006 [17];
- f) 0x0A, it refers to a transport stream carrying a System Software Update BAT or NIT with detailed signalling information about System Software Update services, see TS 102 006 [17].

The meaning of other values of linkage_type is not defined in this context. Note that the linkage_type does not indicate the service_type of the referenced service. An example of the intended use of the linkage descriptor is that an IRD user interface could include a mechanism like "info about the network" which would make the IRD tune to the linked service after the user initiated the mechanism.

4.2.1.1.2 Multilingual network name descriptor

This descriptor may be used to convey the name of the network in one or more languages. It may be included once in the descriptor loop. Inclusion of this descriptor is optional.

4.2.1.1.3 Network name descriptor

This descriptor is used to transmit the name of a physical network, e.g. "ASTRA", "EUTELSAT", "MUNICH CABLE" etc. This descriptor shall be used exactly once in any NIT sub-table.

4.2.1.1.4 Cell list descriptor

This descriptor is only allowed in a Network Information Table (NIT) that describes a terrestrial network. It is used to list the cells of a network. If cell identification by means of the TPS bits (EN 300 744 [8]) is supported for hand-over purposes then the descriptor shall be present. Otherwise, the transmission of this descriptor is optional. If it is present, the cell list shall be complete. The descriptor is allowed more than once in the loop.

Due to the definition regarding the sign of latitudes and longitudes one has to specify the south-western corner of the rectangle.

4.2.1.2 Second descriptor loop

Only the DVB SI descriptors in this clause have a defined meaning in the second loop of the NIT.

4.2.1.2.1 Delivery system descriptors

The delivery system descriptors are the `satellite_delivery_system_descriptor`, `cable_delivery_system_descriptor` and the `terrestrial_delivery_system_descriptor`. Descriptors for other delivery systems may be defined in the future. The `delivery_system_descriptors` are used to transmit the physical parameters for each transport multiplex in the network.

One (and only one) delivery system descriptor shall appear in each loop. IRDs shall be able to interpret the delivery system descriptor in order to tune to TSs quickly (see clauses 4.1.1 and 5.3.1).

4.2.1.2.2 Service list descriptor

This descriptor is used to list the services and service types for each TS. The services are listed identified by `service_id` (= MPEG-2 `program_number`). The `transport_stream_id` and `original_network_id`, which are necessary to identify a DVB service uniquely, are given at the start of the descriptor loop.

The service list descriptor is allowed only once in each loop. Transmission of this descriptor is optional, but if it is present, then the service list shall be complete.

4.2.1.2.3 Frequency list descriptor

This descriptor lists the additional frequencies used in transmission of a multiplex on other frequencies.

The `frequency_list` descriptor is allowed only once in each loop for which there is a delivery system descriptor. Inclusion of this descriptor is optional, but if it is present, then the list of frequencies shall be complete.

4.2.1.2.4 Cell frequency link descriptor

This descriptor is only allowed in a Network Information Table (NIT) that describes a terrestrial network. It is used to provide links between a cell and the frequencies that are used in this cell for the transport stream described. If cell identification by means of the TPS bits (EN 300 744 [8]) is supported for hand-over purposes then the descriptor shall be present. Otherwise it is optional. If it is present, the frequency list within the descriptor shall be complete. The descriptor is allowed more than once in the loop.

4.2.2 Descriptors of the Bouquet Association Table (BAT)

The BAT is organized as follows:

```
/* header ....*/
for i = 0; i < N; i++ { /* 1st descriptor loop */
    descriptor()
}
for ( i = 0; i < N; i++) {
    /* loop over Transport Streams */
    transport_stream_id
    original_network_id
    for ( j = 0; j < M; j++) { /* 2nd descriptor loop */
        descriptor()
    }
}
/* CRC etc. */
```

The BAT has the same structure as the NIT. The BAT gives a logical grouping of services into bouquets, which may group together services delivered by different networks. A TS may contain services from more than one bouquet within a network. Each BAT collects the services that are allocated to the specified bouquet.

4.2.2.1 First descriptor loop

Only the DVB SI descriptors in this clause have a defined meaning in the first loop of the BAT.

4.2.2.1.1 Bouquet name descriptor

This descriptor is used to transmit the name of the bouquet the following services are allocated to, e.g. "THE NEWS BOUQUET", "HEAVEN MOVIE CHANNELS" etc. This descriptor is allowed once in each sub-table of the BAT. It is mandatory to be transmitted in any BAT sub-table in the TS.

4.2.2.1.2 CA identifier descriptor

Transmission of this descriptor is optional; it is allowed only once in this loop. It identifies one or more CA systems which apply to the services in the BAT.

4.2.2.1.3 Country availability descriptor

This descriptor is used to indicate whether a bouquet is available in a specific country. It has no meaning in the sense of CA. However, it may be a good feature for IRDs to interpret this descriptor, not to display bouquets that are not available in order to avoid frustration of the user.

This descriptor is allowed a maximum of twice in each BAT sub-table, once to indicate a list of countries in which the bouquet is intended to be available, and once to indicate those countries in which it is not intended to be available. If the descriptor is not present, the availability status of the bouquet is undefined. Transmission of this descriptor is optional.

4.2.2.1.4 Linkage descriptor

This descriptor is used to give a link to another service or TS. If it appears in this loop it links to a service that is attached to the bouquet provider. The `linkage_descriptor` is allowed more than once in this loop, for example it could point to the "Heaven movie teasers" and to "Heaven text TV". Transmission of this descriptor is optional. The meaning of the descriptor when it occurs here depends on the value of the `linkage_type`. If the `linkage_type` is:

- a) 0x01, the descriptor refers to a service that contains information about the bouquet. An example of the intended use is for the IRD to switch to the information service when the user requests additional information about the bouquet;
- b) 0x02, the descriptor refers to an Electronic Program Guide (EPG) for the bouquet;

NOTE: The IRD can only make use of this type of linkage if it can decode the EPG service. The present document does not specify the contents of such a service.

- c) 0x04, it refers to a TS which carries comprehensive Service Information. The SI carried in the referenced TS includes at least all the SI information available on all other TSs which carry services of the bouquet;
- d) 0x09, it refers to a transport stream carrying a System Software Update service, see TS 102 006 [17];
- e) 0x0A, it refers to a transport stream carrying a System Software Update BAT or NIT with detailed signalling information about System Software Update services, see TS 102 006 [17].

The meaning of other values of `linkage_type` is not defined in this context. Note that the `linkage_type` does not indicate the `service_type` of the referenced service. An example of the intended use of the linkage descriptor is that an IRD user interface could include a mechanism like "info about the bouquet" which would make the IRD tune to the linked service after the user initiated the mechanism.

4.2.2.1.5 Multilingual bouquet name descriptor

This descriptor may be used to convey the name of the bouquet in one or more languages. It may be included once in the descriptor loop. Inclusion of this descriptor is optional.

4.2.2.2 Second descriptor loop

Only the DVB SI descriptors in this clause have a defined meaning in the second loop of the BAT.

4.2.2.2.1 Service list descriptor

This descriptor is used to list the services and service types for each TS that belong to the bouquet of this section. This allows the IRD to find all services that belong to a specific bouquet.

The `service_list_descriptor` is allowed only once in each loop. It should be transmitted if a BAT exists.

4.2.3 Descriptors of the Service Description Table (SDT)

The SDT is organized as follows:

```
table_id      /* distinction between actual & foreign MUXes */
/* header ....*/
transport_stream_id
original_network_id
for i = 0; i < N; i++ { /* descriptor loop */
    service_id
    EIT_schedule_flag
    EIT_present_following_flag
    running_status
    free_CA_mode
    for ( j = 0; j < M; j++){
        descriptor()
    }
}
/* CRC etc. */
```

The SDT has a loop for descriptors for each service described in the SDT. Only the DVB SI descriptors in this clause have a defined meaning in the SDT.

4.2.3.1 Announcement support descriptor

The announcement support descriptor informs about announcements supported by the service. It is an optional descriptor and allowed only once in each loop.

4.2.3.2 Bouquet name descriptor

This descriptor is used to transmit the name of the bouquet the service is allocated to, e.g. "THE NEWS BOUQUET", "Heaven movie channels", etc. This descriptor is allowed more than once in the loop because a service could belong to more than one bouquet. It is not allowed if there is a `time_shifted_service_descriptor`.

Transmission of this descriptor is optional in the SDT. The use of this descriptor in the SDT is wasteful of bandwidth, since the information can be conveyed more efficiently using the BAT.

4.2.3.3 CA identifier descriptor

If a service is generally CA-protected, this descriptor may be used to transmit data of the CA-system.

The `CA_identifier_descriptor` is not involved in any CA control function, it is an indication for the user interface software in the IRD that a service is under conditional access and which CA-system is used. Then the user interface software may decide whether this service is reachable or not. The aim of the transmission of this descriptor is to avoid frustration to users caused by services being displayed for selection that are not reachable.

This descriptor is allowed only once in the loop. It is not allowed if there is a `time_shifted_service_descriptor`. Transmission of this descriptor is optional in the SDT.

4.2.3.4 Country availability descriptor

This descriptor is used to indicate whether a service is available in the specified country. It has no meaning in the sense of CA, however it may be a good feature for IRDs to interpret this descriptor, not to display services that are not available in order to avoid frustration of the user.

This descriptor is allowed a maximum of twice in each SDT service loop, once to indicate a list of countries in which the service is intended to be available, and once to indicate those countries in which it is not intended to be available. If the descriptor is not present, the availability status of the service is undefined. It is not allowed if there is a `time_shifted_service_descriptor`.

Transmission of this descriptor is optional.

4.2.3.5 Data_broadcast_descriptor

See clause 4.2.7.3.

4.2.3.6 Linkage descriptor

This descriptor is used to give a link to another service. If it appears in this loop it links to a service that is attached to this service. Transmission of this descriptor is optional. More than one linkage descriptor is allowed in a loop. The meaning of the descriptor, when it occurs here, depends on the value of the `linkage_type`. If the `linkage_type` is:

- a) 0x01, the descriptor refers to a service that contains information about this service. An example of the intended use is for the IRD to switch to the information service when the user requests additional information about this service;
- b) 0x02, the descriptor refers to an Electronic Program Guide (EPG) for this service;

NOTE 1: The IRD can only make use of this type of linkage if it can decode the EPG service. This ETR does not specify the contents of such a service.

- c) 0 x 03, the descriptor refers to a CA replacement service for this service. An example of the intended use is for the IRD to switch automatically to the replacement service if the CA system denies access to this service;
- d) 0 x 05, the descriptor refers to a replacement service for this service. An example of the intended use is for the IRD to switch automatically to this replacement service when the selected service has a running status of "not running";

NOTE 2: The `linkage_type` does not indicate the `service_type` of the referenced service.

An example of the intended use of the linkage descriptor is that an IRD user interface could include a mechanism like "info about the service", which would make the IRD tune to the linked service after the user initiated the mechanism.

- e) 0 x 08, it refers to a service in a terrestrial network to which the receiver might tune to if the actual service is no longer receivable under its `service_id`. The `hand-over_type` indicates whether the `linkage_descriptor` is used to link to an identical service in a neighbouring country, to a local variation of the service or an associated service.

4.2.3.7 Mosaic descriptor

This descriptor may be located in the SDT and/or PMT. It is used to describe mosaic services as described in clause 5.2. It is not allowed if there is a `time_shifted_service_descriptor`.

4.2.3.8 Multilingual service name descriptor

This descriptor may be used to convey the name of the service provider and service name in one or more languages. It is allowed only once in the descriptor loop. Inclusion of this descriptor is optional.

4.2.3.9 NVOD reference descriptor

This descriptor lists the services which belong to a Near Video On Demand (NVOD) service. A description of the NVOD-mechanisms is given in clause 5.1.

The `NVOD_reference_descriptor` is allowed only once in each loop. It is mandatory to be transmitted if the corresponding services are described using the `time_shifted_service_descriptor`.

IRDs are recommended to make use of the `NVOD_reference_descriptor` in order to allow access to NVOD-services.

4.2.3.10 Service descriptor

This descriptor contains the basic textual identifications of a service such as service name and provider name.

The `service_descriptor` is allowed only once in each loop and if there is no `time_shifted_service_descriptor`.

It is mandatory to be transmitted. IRDs are recommended to make use of it in order to display the service names in the user interface.

4.2.3.11 Service availability descriptor

This descriptor is used in the SDT to provide a link between a service in a terrestrial network and the network cells in which it is available or unavailable. Transmission of this descriptor is optional. The descriptor is allowed more than once in the loop.

This descriptor may be used in terrestrial networks, for local services which are not present on the whole network. In this case, the association between the multiplex and the cell on which it is broadcast is made by the insertion of the `cell_id` in the TPS bits of the radiated multiplex. By extracting this information from the TPS bits, and using the descriptor in the SI, the receiver is able to build a service list containing only the relevant services available in the cells it is currently able to receive. The mechanism prevents the user from being presented services which are in fact not receivable at his/her current location.

In a specific multiplex / `cell_id` combination the components of all services indicated to be available in the `SDT_actual` **shall** be available in the multiplex if the service is running, and the services in the `SDT_actual` matching the `cell_id` **shall** describe all services available in the multiplex. The `SDT_actual` **shall** describe all services occurring in all multiplexes of a network that match its `transport_stream_id`. The SDT **shall not** contain multiple instances of the same `service_id`: `service_id` shall remain a unique identification of the service in a network and aliases based on `cell_id` distinction are not allowed.

It is not the intention to describe multiplexes that are only distinguished by `service_availability` separately in the NIT and BAT. Therefore, in the second loop of the NIT and BAT there shall be at most one association between `<original_network_id>`, `<transport_stream_id>` and the `frequency_list_descriptor`. The same shall apply for `service_list_descriptor`. Note: both `frequency_list_descriptor` and `service_list_descriptor` remain optional when local service availability is used in a network.

Mixed use of `service_availability` qualification of services in a network or even in a multiplex is possible. A service not linked to a particular `service_availability_descriptor` shall be considered available in all cells transmitting the multiplex.

4.2.3.11.1 Network Implementation Considerations (NIC)

By using the `service_availability_descriptor`, network operators can create one SI for multiple multiplexes in a network, yet still define specific subsets of these services to be valid for the different transmitters in a network (i.e. this creates one large "virtual" transport stream of which only the relevant parts are transmitted on each transmitter). A typical example purpose for this are local variations of one 'mother' service carried in a transport stream. The SI may be the same for 4 multiplexes, but each of these multiplexes may carry a different set of services and indicate (through the association between `cell_id` and `service_availability` descriptor) which of the services are actually carried in a specific instance of the multiplex. The only differentiation between these multiplexes is made in the receiver through the link with the `cell_id`. It is also clear that the PSI information of different multiplexes should be consistent (as normal) and should not contain PSI for services that are not available. I.e. the network operator may use a central SI generator but should (re)multiplex the multiplexes at the PSI and ES level.

When defining terrestrial networks and local variations on these networks, the number of network cells and the association between the cells and the services have to be carefully defined in order to control the amount of SI information in the multiplex because the SDT and EIT carried in all multiplexes will grow as the common SI has to carry more service instances.

The network operator should be aware that resolution of `linkage_descriptor` information and other references to transport streams only via `transport_stream_id` may no longer be uniquely possible by an IRD. So in case such a reference is made the specific resolution to multiplex **shall** be arbitrary. Note that resolution to a service carried in a specific multiplex from the `service_id` should still be uniquely possible (if the multiplex(es) carrying it can be received by the IRD).

4.2.3.11.2 IRD implementation considerations

The recommendations below should be followed to allow optimal functionality in networks deploying service_availability_descriptors:

- It is recommended to match SDT and EIT information (depending on the purpose of use) either with:
 - Cell_id of current multiplex (for deriving information on the currently tuned multiplex).
 - Cell_ids of all receivable instances of a multiplex (for deriving information on all receivable services including cross-carriage information for multiplexes with the same transport_stream_id).
 - No matching on cell_id for generating the most abundantly available SI information.
- It is recommended to make all receivable multiplexes with the same transport_stream_id but with different cell_ids available to the user, and only when a service (not a transport stream) is available through multiple multiplexes to select a preferred multiplex based on e.g. reception quality.

Any reference resolution from a transport_stream_id or a service_id (e.g. from a linkage_descriptor transport_stream_id/service_id pair) to a multiplex / frequency requires consideration to handle the potential multiplicity of the result.

Note that in networks deploying the service_availability_descriptor, the unique identification of a transport stream by the tuple (transport_stream_id, original_network_id), can often be sensibly replaced by identification through the triplet (transport_stream_id, original_network_id, cell_id).

4.2.3.12 Telephone descriptor

Transmission of this descriptor is optional, and it may occur more than once in the loop. It is not allowed if there is a time_shifted_service_descriptor.

IRDs cannot make use of it without further information (see annex A).

4.2.3.13 Time shifted service descriptor

This descriptor identifies a service as a time shifted copy of another service (clause 5.1).

The time_shifted_service_descriptor is allowed only once in each loop. It is mandatory to be transmitted for services listed in a NVOD_reference_descriptor.

If a time_shifted_service_descriptor is present in a descriptor loop, the following descriptors are not allowed in the same descriptor loop:

- multilingual_service_descriptor;
- CA_identifier_descriptor;
- country_availability_descriptor;
- mosaic_descriptor;
- telephone_descriptor;
- bouquet_name_descriptor;
- service_descriptor.

IRDs are recommended to be able to interpret it in order to access NVOD-events.

4.2.4 Descriptors of the Event Information Table (EIT)

An EIT-section is organized as follows:

```

table_id      /* classification of the EI-section : present following etc. */
/* header ....*/
service_id
transport_stream_id
original_network_id
for i = 0; i < N; i++ { /* descriptor loop */
    event_id
    start_time
    duration
    running_status
    free_CA_mode
    for ( j = 0; j < M; j++){
        descriptor()
    }
}
/* CRC etc. */

```

The EIT has a loop for descriptors for each event described in the EIT.

Only the DVB SI descriptors in this clause have a defined meaning in the loop.

4.2.4.1 CA identifier descriptor

If an event is CA-protected, this descriptor may be used to transmit data of the CA-system. The CA_identifier_descriptor is not involved in any CA control function, it is an indication for the user interface software in the IRD that the event is under conditional access and which CA-system is used. Then the user interface software may decide whether this service is reachable or not. The aim of the transmission of this descriptor is to avoid frustration to users caused by events being displayed for selection that are not reachable.

This descriptor is allowed only once in the loop. It is not allowed if there is a time_shifted_event_descriptor. Transmission of this descriptor is optional in the EIT.

4.2.4.2 Component descriptor

This descriptor is used to specify streams that are attached to an event. The descriptor may appear more than once in a loop since there may be more than one stream.

If there is a time_shifted_event_descriptor, this descriptor is not allowed.

Transmission of this descriptor in the EIT Present/Following for the actual TS is mandatory for all Elementary Streams except those coded according to the data broadcasting specification, for which the data broadcasting descriptor may be used.

It is optional for other EITs. It is useful to indicate which streams will be available for future events.

4.2.4.3 Content descriptor

This descriptor is used to classify the content of the event. Only one content descriptor may appear in the loop, but there is the possibility to transmit more than one classification term because there is a loop within the descriptor.

If there is a time_shifted_event_descriptor, this descriptor is not allowed, since the content information can be provided in the EIT sub-table for the corresponding NVOD reference service. Transmission of this descriptor is optional.

4.2.4.4 Data_broadcast_descriptor

See clause 4.2.7.3.

4.2.4.5 Extended event descriptor

This descriptor is used to transmit a bigger amount of textual information for an event than is possible with the short_event_descriptor. The information in extended event descriptors supplements that given in a short event descriptor. A language code is transmitted in order to indicate in which language the text is written. More than one extended_event_descriptor is allowed, for transmitting more data than one descriptor may contain (255 bytes excluding header) and for different languages. The last_descriptor field specifies the number of the last extended_event_descriptor for a specific language.

If there is a time_shifted_event_descriptor, this descriptor is not allowed. Transmission of this descriptor is optional.

4.2.4.6 Linkage descriptor

This descriptor is used to give a link to another service. If it appears in this loop it links to a service that is attached to this event. Transmission of this descriptor is optional. If there is a time_shifted_event_descriptor, this descriptor is not allowed. More than one linkage descriptor is allowed in a loop. The meaning of the descriptor, when it occurs here, depends on the value of the linkage_type. If the linkage_type is:

- 0x01, the descriptor refers to a service that contains information about this event. An example of the intended use is for the IRD to switch to the information service when the user requests additional information about this event.

The meaning of other values of linkage_type is not defined in this context. Note that the linkage_type does not indicate the service_type of the referenced service. An example of the intended use of the linkage descriptor is that an IRD user interface could include a mechanism like "info about the event" which would make the IRD tune to the linked service after the user initiated the mechanism.

4.2.4.7 Multilingual component descriptor

This descriptor may be used to convey text describing a component of an event in one or more languages. It may be included once in the descriptor loop for each component of an event. If there is a time_shifted_event_descriptor, then this descriptor is not allowed. Inclusion of this descriptor is optional.

4.2.4.8 Parental rating descriptor

This descriptor is used to give a rating of the programme based on age or other criteria that is used to prevent children from viewing unsuitable programmes. If there is a time_shifted_event_descriptor, this descriptor is not allowed, since the parental rating information can be provided in the EIT sub-table for the corresponding NVOD reference service. The parental_rating_descriptor may appear just once in a loop. Transmission of this descriptor is optional.

Country_codes relating to groups of countries may be used within the descriptor. If, as a result, there is more than one entry for a country in the descriptor, then the first entry in the descriptor which includes the country shall take precedence over any subsequent entry. For example, the following sequence of data within the descriptor would describe a parental rating of minimum age of 12 in all countries except UK, for which the minimum age is 18.

EXAMPLE: country_code = UK
 rating = 0x0F
 country_code = all countries
 rating = 0x09

4.2.4.9 PDC descriptor

The PDC_descriptor extends the DVB system with the functionalities of PDC (EN 300 231 [12]). The descriptor carries the Programme Identification Label (PIL) as defined in ETS 300 321 [12]. This label has, in principle, the same function as the DVB event_id, but with the advantage of being available to the public implicitly by many media a long time in advance.

The PIL contains date and time of the first published start time of a certain event. Within analogue systems the PIL is either broadcast in the teletext format or as a part of the VPS label in dataline 16. No change is made to the PIL once it has been made publicly available provided the transmission time remains within the validity time window (ETS 300 321 [12]).

No use shall be made of types of "service codes" (ETS 300 321 [12]) which would imply dynamic changes during a running event. Their function shall only be covered by the RST.

If a service supports the PDC function a PDC descriptor shall appear once in all EIT present/following subtables for the actual TS of the service.

4.2.4.10 Short event descriptor

This descriptor is used to transmit the name and a short text description for an event. A language code is transmitted in order to indicate in which language the title and the text are written. Transmission of this descriptor is mandatory, unless there is a `time_shifted_event_descriptor`, in which case the descriptor is not allowed. This descriptor is allowed more than once in the loop for different languages. Thus it is not allowed to have more than one `short_event_descriptor` with the same language code.

4.2.4.11 Telephone descriptor

Transmission of this descriptor is optional, and it may occur more than once in the loop. IRDs cannot make use of it without further information. See bibliography.

4.2.4.12 Time shifted event descriptor

This descriptor is used to indicate that an event is the time-shifted copy of another event. If this descriptor is present only a `PDC_descriptor`, `private_data_specifier_descriptors` and private descriptors are allowed in the loop.

Transmission of this descriptor is mandatory in case of NVOB. IRDs are recommended to decode this descriptor, without which access to the Service Information of NVOB events is not possible.

4.2.5 Descriptors of the Time Offset Table (TOT)

4.2.5.1 Local time offset descriptor

This descriptor may be used to indicate the local time offset and the automatic adjustment between summer and winter time by an IRD.

The data given in the descriptor will be constant for most of the time, but will change in the transitions from summer time to winter time and vice versa. In the TOT descriptor loop the local time offset descriptor may occur more than once. It is assumed that the same set of countries/country regions be included in each transmission of the TOT.

If the time of the next change is unknown, or there is no next change (in the case of a region that does not use daylight saving) then the `time_of_change` field shall contain a valid value and the `next_time_offset` field shall convey the same value as the `local_time_offset` field.

If a country uses more than one time zone, the `country_region_id` field identifies the different regions of the country with different time zones.

Example data for the descriptor fields:

<code>country_code</code> :	x9yy (European Continent countries group).
<code>country_region_id</code>	000000'.
<code>local_time_offset_polarity</code>	0'.
<code>local_time_offset</code>	'0000000100000000' (Winter: 1 hour).
	'0000001000000000' (Summer: 2 hours).

The descriptor may be applied in the following applications:

- display of the current local time on the IRD or TV screen;
- display of the programme guide in local time;

- timer programming of the video recorder in local time.

4.2.6 Descriptors of the Program Map Table (PMT)

In addition to the descriptors defined in ISO/IEC 13818-1 [2] the following DVB SI descriptors may be used in the PMT.

4.2.6.1 AC-3 descriptor

For guidelines on the inclusion and use of the AC-3 descriptor please refer to annex E of EN 300 468 [1].

4.2.6.2 Adaptation field data descriptor

The adaptation field data descriptor provides a means of indicating the type of data fields supported within the private data field of the adaptation field coded according to ISO/IEC 13818-1 [2]. It shall be inserted into the corresponding ES_info loop of the PMT if the stream contains one or more of the data fields listed in table 14(?) of EN 300 468 [1].

4.2.6.3 Ancillary data descriptor

This descriptor is used to indicate the presence and type of ancillary data in the audio elementary streams coded according to ISO/IEC 13818-3 [13] and ISO/IEC 11172-3 [14]. This descriptor shall be inserted once into the corresponding ES_info loop of the PMT. If the ancillary data adheres to one of the formats in table 16(?) of EN 300 468 [1] the descriptor shall be present. It is recommended that the IRD uses this descriptor to indicate the presence and type of ancillary data to the audio decoder.

The presence of the extended ancillary data field (TR 101 154 [9], annex D) does imply the presence but not the validity of the DVD-Video ancillary data field. Thus,

- $b_0 == 1 \ \&\& \ b_1 == 0$ means that the DVD-Video ancillary data field is present and valid.
- $b_0 == 0 \ \&\& \ b_1 == 1$ means that firstly the extended ancillary data field is present and valid and secondly that the DVD-Video ancillary data field is present but not necessarily valid. In this case the receiver should use the extended version of the dynamic range control data, because it results in better quality.
- $b_0 == 1 \ \&\& \ b_1 == 1$ means that both the DVD-Video ancillary data field and the extended ancillary data field are present and valid.

4.2.6.4 Data broadcast id descriptor

This descriptor is a short form of the data_broadcast descriptor and it may be placed more than once in a component loop of a PSI PMT table. However there may only be at most one instance with a data_broadcast_id value in the range 0x0000 to 0x007F.

4.2.6.5 Mosaic descriptor

This descriptor may be located in the PMT and/or SDT. Its use to describe mosaic services is described in clause 5.2.

4.2.6.6 Service move descriptor

This descriptor provides a mechanism which enables an IRD to track a service which moves from one TS to another. Note that some disturbance to the decoded video and audio will occur at such a transition. The following rules are recommended to minimize the discontinuity:

- a) in the PMT of the service which is to move, a service_move_descriptor is inserted, no earlier than the time that the service commences on the new TS and at least as long as the service continues to exist on the old TS;
- b) the service should be described in the PAT and PMT of the new stream at least from the time that the service_move_descriptor is inserted in the old TS.

If a complete TS is moved, then this can be achieved by updating the NIT tuning information for the TS. In this case the `original_network_id`, `transport_stream_id`, and `service_ids` are unchanged, and the `service_move_descriptor` is not applicable.

4.2.6.7 Stream identifier descriptor

This descriptor enables specific streams to be associated with a description in the EIT, in cases where there are more than one stream of the same type within a service. The descriptor is mandatory only if the service contains more than one stream of the same type and there are component descriptors for that type of stream within the EIT.

4.2.6.8 Subtitling descriptor

This descriptor is used to identify DVB subtitle data which is coded in accordance with EN 300 743 [15]. The descriptor shall be used once in the appropriate `ES_info` field for any stream containing subtitling data coded in accordance with EN 300 743 [15]. The descriptor allows the identification of the language and information on the content of the subtitle. The loop within the descriptor shall appear at least once.

4.2.6.9 Teletext descriptor

This descriptor is used to identify EBU Teletext data which is coded in accordance with EN 300 472 [3]. The descriptor shall be used once in the appropriate `ES_info` field for any stream containing EBU Teletext coded in accordance with EN 300 472 [3]. The descriptor allows the identification of the language and type of particular "reference" pages such as subtitle or index pages. The loop within the descriptor may be omitted, in which case no specific indication of language, Teletext type, or page is given (i.e. equivalent to selecting Teletext on analogue transmissions).

4.2.6.10 VBI data descriptor

The VBI data descriptor is used to signal the transmission of data intended to be transcoded into the VBI of MPEG-2 decoded video as defined in EN 301 775 [10]. Such data may include inverted teletext, VPS, WSS and closed-captioning. Also, a generic format for transmitting luminance-only VBI data is defined to have a means of coping with other standard or non-standard VBI systems.

The VBI data descriptor shall be used in the PSI PMT of a stream which carries VBI data as defined EN 301 775 [10]. The appropriate `ES_info_field` of the program map section describing a VBI data stream shall contain one and only one `VBI_data_descriptor`.

For transmission of multiple VBI data streams in one service a `VBI_data_descriptor` in each of the component loops of the program map section is required.

4.2.6.11 VBI teletext descriptor

EN 301 775 [10] allows for conveying VBI data units and EBU teletext data units using the same elementary stream. Backwards compliance with the EN 300 472 [3] is guaranteed, as the EBU teletext as specified in EN 300 472 [3] and VBI data as specified in EN 301 775 [10] can co-exist in the same service on separate streams.

The `VBI_teletext_descriptor` is used in case of conveying VBI data units and EBU teletext data units using the same elementary stream. This is especially useful in areas where minimization of the number of synchronized PID streams is important. For example, in primary distribution, existing head-end receivers may only be capable of receiving one stream for both VBI and teletext data.

4.2.7 Other descriptors

4.2.7.1 Private data specifier descriptor

This descriptor is used to identify the source of any private descriptor or user defined field within any descriptor. If this descriptor is located within a descriptor loop of any SI or PSI Table then its specifier applies to all following descriptors in the particular descriptor loop until its end, or until another occurrence of a `private_data_specifier_descriptor`, whichever comes first.

The effect of a `private_data_specifier_descriptor` in a descriptor loop does not propagate to any following descriptor loop.

The usage of the `private_data_specifier_descriptor` is not mandatory but recommended since it is the only means for a decoder to determine the source of a private descriptor or privately defined value and therefore its appropriate handling.

4.2.7.2 Stuffing descriptor

This descriptor is allowed in any place in the SI where descriptors are allowed. It is used to stuff tables for any reason or to disable descriptors that are not valid (e.g. in case of re-multiplexing). An IRD should skip over a `stuffing_descriptor`.

4.2.7.3 Data_broadcast_descriptor

This descriptor is used to identify within the SI (SDT and/or EIT) data broadcast services in the DVB framework. For service based implementation of data broadcasting it is recommended to place the descriptor within the SDT. For an event oriented data broadcasting service, a descriptor may also be placed within the EIT.

Within this descriptor there is a field called `data_broadcast_id`, identifying the type of data service within the multiplex. The allocation of the values is given in TR 101 162 [4].

Values 0x0001-0x0007 of the `data_broadcast_id` (see TR 101 162 [4]) are specified in EN 301 192 [5]. Guidelines for the use of EN 301 192 [5] are given in TR 101 202 [6].

A range of values (0x0100 - 0xFFFFE) can be used for the registration of private data broadcast systems. TR 101 162 [4], which is frequently updated, gives a list of all registered `data_broadcast_ids`.

4.2.7.4 Transport_stream_descriptor

This descriptor being transmitted in the TSDT (see ISO/IEC 13818-1 [2]) only, is used to indicate the compliance of a transport stream with an MPEG based system, e.g. DVB.

For identification of DVB Transport Streams the byte field of the descriptor shall contain the values 0x44, 0x56, 0x42 (ASCII: "DVB").

For identification of DSNG Streams the byte field of the descriptor shall contain the values 0x44, 0x53, 0x4E, 0x47 (ASCII: "DSNG").

4.2.8 ISO/IEC 13818-1 descriptors

The following ISO/IEC 13818-1 [2] (MPEG-2) descriptors can be expected in the DVB SI bit streams:

- `registration_descriptor`;
- `private_data_descriptor`;
- `copyright_descriptor`;
- `ISO_639_language_descriptor`.

This descriptor lists the different languages in which a service/event is broadcast. This descriptor may be present in the SDT (and in the EIT). When present, the descriptor can be used by the IRD to select services or events with a language criterion. When this descriptor is used within the DVB SI bit streams the audio type field should be set to the value 0x00 (undefined).

The meaning of other MPEG-2 defined descriptors is not defined if included in the DVB SI tables.

4.2.9 Unknown descriptors

If a DVB-defined descriptor appears in a context where its meaning is not specified in this ETR, or if the IRD encounters a descriptor with an unrecognized tag, the IRD is recommended to skip over that descriptor (using the length field) and proceed with decoding the following SI data.

4.3 Program Specific Information (PSI) and DVB SI operational interaction states

For the description of a service state the following four columns of table 4 are relevant:

- Program Association Table (PAT),
- PMT,
- SDT; and
- EIT.

The possible indications given by these tables for a service are listed in table 3. The first three columns and the fifth column give the possible combinations of the existence of the four tables, the fourth column lists the relevant combinations of the running status bits in the SDT.

For information about the states of the `running_status` field in event information, see clause 4.1.4.

Table 3: Service state

Service present in					State of the service
PAT	PMT	SDT	SDT running status	EIT p/f	
yes	no	x	x	x	Transition state
no	yes	x	x	x	Transition state
yes	yes	no	-	x	Transition state
yes	yes	yes	x	no	Transition state
yes	yes	yes	running or undefined	yes	Service is running and broadcasting
yes	yes	yes	pausing or not running	x	Transition state
no	no	no	-	yes	Transition state
no	no	no	-	no	Idle state, corresponds to the start of the creation of a service or end state of a service
no	no	yes	running	x	Transition state
no	no	yes	pausing, not running or undefined	x	The service definition still exists => The service will broadcast again

4.4 Minimum repetition rates

4.4.1 Satellite and cable delivery systems

For satellite and cable delivery systems, where there will usually be sufficient bandwidth within a single delivery system to carry the SI, the following minimum repetition rates are specified:

- a) all sections of the NIT shall be transmitted at least every 10 s, including those for other delivery systems, if present;
- b) all sections of the BAT shall be transmitted at least every 10 s, if present;
- c) all sections of the SDT for the actual multiplex shall be transmitted at least every 2 s;
- d) all sections of the SDT for other TSs shall be transmitted at least every 10 s, if present;
- e) all sections of the EIT Present/Following Table for the actual multiplex shall be transmitted at least every 2 s;
- f) all sections of the EIT Present/Following Table for other TSs shall be transmitted at least every 10 s, if present;
- g) all sections of the EIT Schedule Table for the first 8 days shall be transmitted at least every 10 s, including those for other TSs, if present;

- h) all sections of the EIT Schedule Table for further than 8 days ahead shall be transmitted at least every 30 s, including those for other TSs, if present;
- i) the TDT and the TOT shall be transmitted at least every 30 s.

4.4.2 Terrestrial delivery systems

For terrestrial delivery systems bandwidth within a single transmitted TS is a valuable resource and in order to safeguard the bandwidth allocated to the primary services receivable from the actual multiplex, the following minimum repetition rates are specified in order to reflect the need to impose a limit on the amount of available bandwidth used for this purpose:

- a) all sections of the NIT shall be transmitted at least every 10 s;
- b) all sections of the BAT shall be transmitted at least every 10 s, if present;
- c) all sections of the SDT for the actual multiplex shall be transmitted at least every 2 s;
- d) all sections of the SDT for other TSs shall be transmitted at least every 10 s if present;
- e) all sections of the EIT Present/Following Table for the actual multiplex shall be transmitted at least every 2 s;
- f) all sections of the EIT Present/Following Tables for other TSs shall be transmitted at least every 20 s if present.

The repetition rates for further EIT tables will depend greatly on the number of services and the quantity of related SI information. The following transmission intervals should be followed if practicable but they may be increased as the use of EIT tables is increased. The times are the consequence of a compromise between the acceptable provision of data to a viewer and the use of multiplex bandwidth.

- a) all sections of the EIT Schedule table for the first full day for the actual TS, shall be transmitted at least every 10 s, if present;
- b) all sections of the EIT Schedule table for the first full day for other TSs, shall be transmitted at least every 60 s, if present;
- c) all sections of the EIT Schedule table for the actual TS, shall be transmitted at least every 30 s, if present;
- d) all sections of the EIT Schedule table for other TSs, shall be transmitted at least every 300 s, if present;
- e) the TDT and TOT shall be transmitted at least every 30 s.

4.5 Terrestrial systems

4.5.1 Terms used within terrestrial systems

In the context of SI the following definitions apply:

transmitter: equipment, that allows to modulate a baseband transport stream and to broadcast it on one frequency, is called transmitter

repeater: equipment which allows to receive a DVB-T signal and to re-transmit it. It does not allow to change the TPS bits and thus the cell_id

transposer: type of repeater which allows to receive a DVB-T signal and to re-transmit it on a different frequency

gap filler: type of repeater which allows to receive a DVB-T signal and to re-transmit it on the same frequency

emitting site: collection of transmitters and/or repeaters gathered on one geographic plant

service insertion point: emitting site at which a transport stream is compiled in order to broadcast it within one network

NOTE: The compilation includes the insertion of signalling data.

cell: geographical area that is covered with DVB-T signals by means of one or more transmitters each radiating a particular transport stream on only one frequency

NOTE: The cell may in addition contain repeaters. Two neighbouring cells may have an intersection. The cell_id that is used to uniquely identify a cell shall be unique within each original_network_id.

subcell: geographical area that is part of the cell's coverage area and that is covered with DVB-T signals by means of a transposer

NOTE: In conjunction with the cell_id the cell_id_extension is used to uniquely identify a subcell.

Multi Frequency Network (MFN) mode: geographical area is operated in MFN mode if the frequencies used to broadcast a specific transport stream differ from one emitting site to another

Single Frequency Network (SFN) mode: geographical area is operated in SFN mode if the frequencies used to broadcast a specific transport stream does not differ from one emitting site to another

network: geographical region in which one or more DVB-T transport streams are receivable each of which is identical within the whole region

NOTE: A network is identified by its network_id. It might be composed of one or more emitting sites.

It is allowed to overlay networks so that the receiver might receive transport streams from more than one network at its actual position. Emitting sites may broadcast transport streams from different networks.

A transport stream which belongs to one network is not allowed to differ from one transmitter to another (see above) except for different audio, video and data components due to regional variations. PSI and SI has to remain unchanged. One should be aware of the fact that the receiver might toggle between components with different content since the transmission of different local components is not signalled.

A network may be based:

- exclusively on the MFN mode. In this case each cell of the network is operating in MFN mode, namely for all transport streams of the network;
- exclusively on the SFN mode. In this case each cell of the network is operating in SFN mode, namely for all transport streams of the network;
- on a mixture of the MFN and SFN mode. In this case some cells of the network are operating in MFN mode and some others are operating in SFN mode and/or some transport streams are broadcast in the MFN mode whereas other transport streams are broadcast in the SFN mode.

The definition of the term "network" in DVB-T systems allows for different implementations. Some examples shall be given for the ease of understanding:

- a) The network design might be based on a juxtaposition of regional networks with only an insignificant overlap in their coverage areas. Each network is composed of a service insertion point and of other emitting sites which may allow local variations of services by substitution of the components. These independent regional networks may use both MFN and SFN modes. The compilation of the terrestrial multiplexes and the insertion of SI are carried out at the service insertion points. For the introduction of new services with a different coverage area than the existing regional networks (e.g. local services) the existing network is divided into two networks that means a new network is built. Within the coverage area of the new network all transport streams of the existing network are shifted to the new network. Stationary or portable receivers in the coverage area of this new network have to refresh their data bases. If NIT others are not offered then the hand-over support for mobile receivers is insufficient since it is impossible to track services that are spread over several networks.
- b) The network design might be based on a juxtaposition of regional networks, an additional national network which have the same coverage area as the regional networks all together and local networks which cover only one part of a regional network, so that a stack of networks arises. Each network is composed of a service insertion point and of other emitting sites which may allow local variations of services by substitution of the components. These independent regional networks may use both MFN and SFN modes. The compilation of the terrestrial multiplexes and the insertion of SI are carried out at the service insertion points. The transmission of NIT others are mandatory for neighbouring networks including other networks at the same location. This cross carriage of SI in the transport streams is applied to allow easy tracking of the services.

- c) The network design might be based on a juxtaposition of cells with only an insignificant overlap in their coverage areas. Each cell has an own service insertion point that means one network corresponds to one cell. Consequently, only one frequency is in use per transport stream and network. This frequency is signalled in the `terrestrial_delivery_system_descriptor`. The `frequency_list_descriptor` is not used. The frequencies of the neighbouring cells, i.e. the neighbouring networks, are provided by means of the `terrestrial_delivery_system_descriptor` in the NIT others. NIT others should exclusively be provided for the neighbouring cells. The networks may use both MFN and SFN modes.
- d) Networks with different dimensions, for example national, regional and local networks, are piled up to a stack of networks. Each network is composed of a service insertion point and of other emitting sites which may allow local variations of services by substitution of the components. The independent networks may use both MFN and SFN modes. The compilation of the terrestrial multiplexes and the insertion of SI are carried out at the service insertion points. National service providers can establish national networks in order to not be forced to re-compile their multiplexes for every regional or local network. Regional service provider can establish regional networks in order to not be forced to re-compile their multiplexes for every local network. A limited number of networks at one location is recommended.

Local SI insertion: local SI insertion means that individual SI is inserted for each cell

NOTE: Consequently, one cell corresponds to one network.

4.5.2 The use of alternative frequencies for multiplexes

The NIT shall signal the use of possible alternative frequencies. Three solutions may be implemented:

1. Use the `other_frequency_flag` in the `terrestrial_delivery_system_descriptor` to advise the IRD that the identical multiplex may be receivable on other centre frequencies. The IRD may, for example, try scanning for a more reliable signal.
2. Use the `frequency_list_descriptor` in order to provide a list of all the possible frequencies used in transmitting a particular multiplex within the network. This descriptor is in the second descriptor loop of the NIT and so it is specific to a single transport stream. The IRD may, for example, try to determine the best signal to use at the time. In comparison with the first solution this solution provides a faster method for an IRD to find usable frequencies.
3. Use the `cell_frequency_link_descriptor` in order to provide the frequency used in a particular cell to transmit a particular multiplex within the network. This descriptor is in the second descriptor loop of the NIT. A mobile IRD may try to determine those of the alternative frequencies that are probably used at its actual position. In comparison with the second solution this solution reduces the risk of tuning failures (see clause 4.5.4.3).

Where the `frequency_list_descriptor` or the `cell_frequency_link_descriptor` are used, it is strongly recommended that the list for each transport stream reflects the same order of emitting sites. Thus, if there are two transport streams in a network each being emitted from the same three emitting sites, then the order in the frequency list descriptor should, for both transport streams, be:

- `emitting_site_1`;
- `emitting_site_2`;
- `emitting_site_3`.

Where one of the emitting sites does not broadcast a particular transport stream the corresponding frequency in the list should be set to zero.

In many cases a receiver will receive all of the available transport streams from a single aerial position. These descriptors can be used to aid the receiver in finding a "best first guess" of the frequency. The IRD can then try first the alternative frequency for a second multiplex which is in the corresponding position within the list for the receivable frequency for the first multiplex.

Table 4: Use of ordered alternative frequency lists

	station_1	station_2	station_3
frequency list for multiplex_A	frequency_1, A	frequency_2, A	frequency_3, A
frequency list for multiplex_B	frequency_1, B	frequency_2, B	frequency_3, B

Where a network covers a large geographical area, it is possible that different emitting sites may use the same frequency for different transport streams. It is therefore important to the viewer that the IRD ensures that the services provided are those which are requested.

In some places, an IRD may be able to receive signals from more than one emitting site which carry different networks. If an IRD receives a signal from one emitting site, it would normally only have information about services from that site. The use of NIT_other and SDT_other is recommended to assist the IRD in finding the services from the other networks. Even though a NIT may indicate that a transport stream is available it does not guarantee that the stream can be received by the IRD. It is important that the IRD should ensure the availability of the service before offering the service to the viewer for selection.

For optimization of the network coverage, operators can broadcast the same transport stream in a network on alternative frequencies using different modulation parameters. The modulation parameters in the terrestrial_delivery_system_descriptor apply to the frequency indicated in the terrestrial_delivery_system_descriptor and may not always apply to alternative frequencies. When the IRD uses an alternative frequency to tune to a transport stream it should not rely on those modulation parameters indicated in the terrestrial_delivery_system_descriptor.

Allocation of network_ids can be found in TR 101 162 [4].

4.5.3 Regional or local services

The insertion of local services is an important feature of terrestrial TV systems (see figure 4). The aim is to have a principal service which, at some precise time, may be displaced in order to provide a regional or local service. Such a local service may occupy the same bandwidth as the principal service at the moment of the switch.

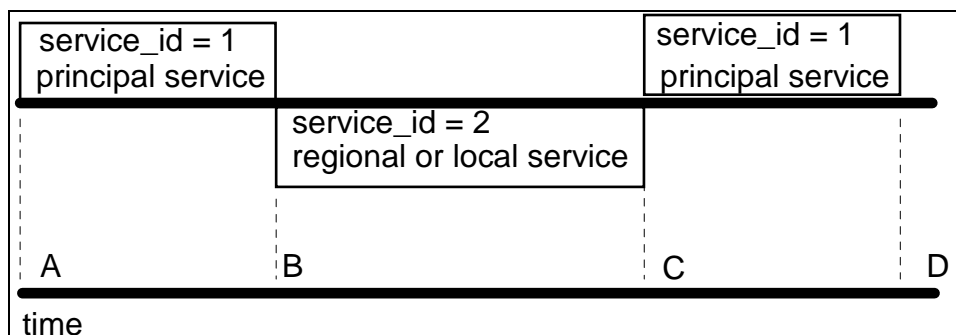

Figure 4: Showing a simple replacement of a principal service by a regional or local service

At time B the principal service, service_id = 1, is displaced by a locally provided service, service_id = 2. This runs from time B to time C at which time the principal service, service_id = 1, is restored. Up to time A the service_id = 1 has a running_status set to "running" and service_id = 2 has a running_status set to "not running". The changes in the SI tables reflect the more precisely timed changes in the PSI tables and streams.

During the period when service_id = 2 is not providing a service it is a null service. This can be achieved by simply providing a reference to the service in the SDT only. PAT and PMT data are not required at this time (see clause 4.3). It is not necessary to provide any video or audio packets and thus the overhead incurred by this null service is reduced to the bits involved in the SDT entry.

The running-status permits the setting of an intermediate state "starts in a few seconds". The IRD may use this period to prepare for the change. At the time of the change the appropriate data, audio and video streams for service_id = 2 are introduced whilst those for service_id = 1 are simultaneously ceased. At the point of change service_id = 1 will become a null service.

The process reverses when service_id = 2 terminates. It may be thought preferable for operational reasons to provide a number of still picture frames, either at black or using a viewable picture, in order to accommodate the effect of switching to a fresh video and audio stream.

The path to the replacement service shall be indicated by the linkage_descriptor using the linkage_type "service replacement service".

More complex service switching operations can be envisaged (see figure 5). These include switching from two services to a single higher bitrate service and from three services to two higher bitrate services.

In either case the changes in the SI tables will reflect the more precisely timed changes in the PSI tables and streams. The IRD must decide what to do at the end of the service replacement. In many cases the IRD will be able to determine that the identity of the service to which it should return from the identity of the service from which it switched. The automatically determined choice may not necessarily be optimal.

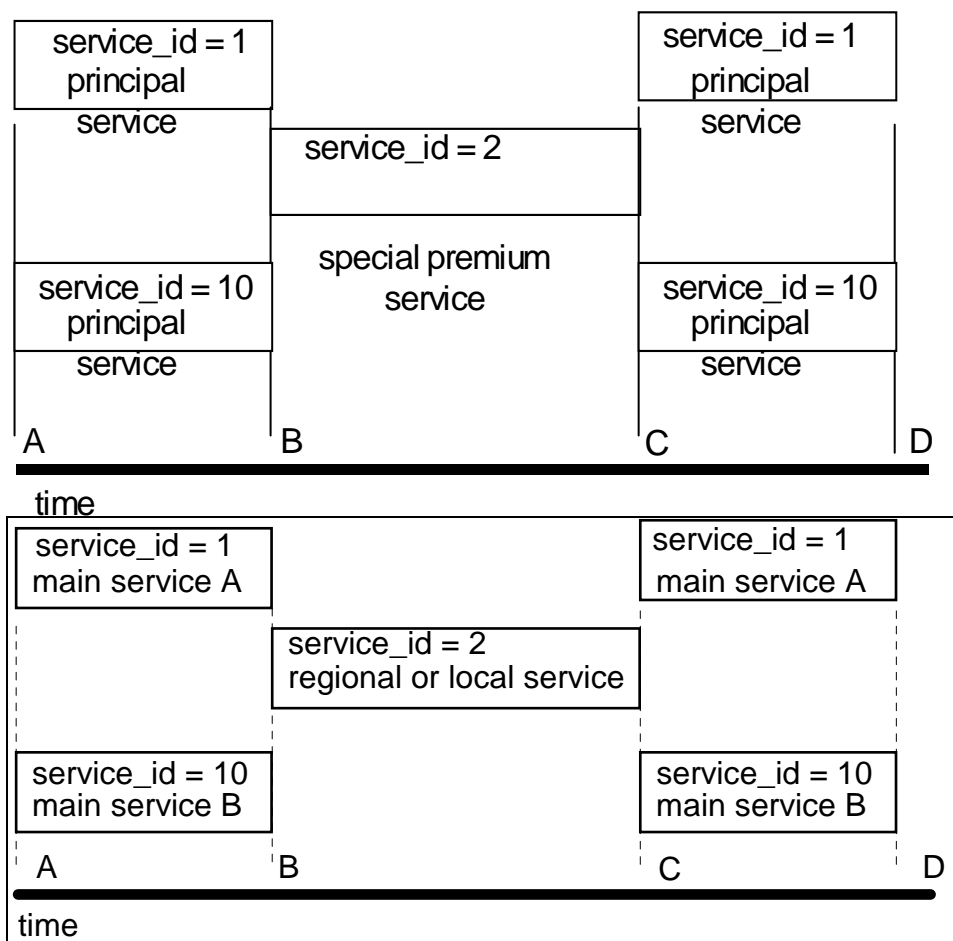

Figure 5: Showing a more complex replacement of two main services by a premium wider bandwidth service

4.5.4 Hand-over

4.5.4.1 General description of the requirements

A stationary or portable IRD can assume that a transport stream on a given frequency will be constantly available during its operation. In contrast, a mobile IRD will face the situation that the selected transport stream signal is no longer available on the tuned frequency if the IRD is moving out of the reception area. In order to continue the selected service, the mobile IRD then needs to automatically select and tune a different frequency carrying either exactly the same transport stream or a different transport stream containing the same service.

If the IRD moved from one cell to another cell of the same network, the same set of transport streams will be available but they will be on different frequencies. The mobile IRD has to determine on which frequency the lost transport stream is transmitted in the entered cell.

If the IRD moved from a cell belonging to one network into a cell of another network then the lost transport stream is not necessarily available. The IRD might want to find out if the service that had been selected before is available on some transport stream of the entered network or if there are alternative services to select.

- a) If the previously selected service is still available, the IRD needs to determine the transport stream that carries the service and the frequency of that transport stream in the entered network.
- b) If the service is not available, the IRD might try to select an alternative service (which could be a local variation of the original service or an associated service) before it prompts the user for a decision. Deploying this mechanism, co-operating networks might provide automatic hand-over between services of similar program type or services which provide additional information such as traffic announcements.

Figure 6 shows the two general hand-over situations: hand-over from one cell to another cell of the same network (network II) and the hand-over between cells of different networks (from network I to network II).

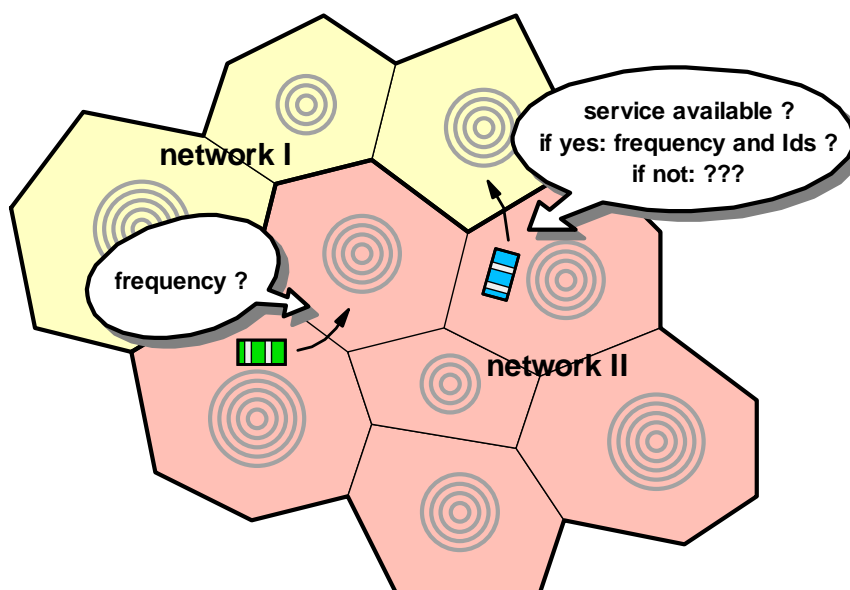

Figure 6: Hand-over situations in DVB-T networks

4.5.4.2 Hand-over by means of the frequency_list_descriptor

If a network consists of multiple cells, then for each transport stream the centre frequency used in one cell is given in the `terrestrial_delivery_system_descriptor`, while for each other cell the frequency is entered in the `frequency_list_descriptor`. Knowing all possible centre frequencies, the IRD only needs to test those frequencies for a sufficient signal strength, decode the transport stream and check for the same pair of `original_network_id` and `transport_stream_id`.

In case the mobile IRD crossed a network border, none of the probed frequencies will lead to the same transport stream. If NIT subtables for the neighbouring networks are transmitted and the lost transport stream is also carried in the neighbouring networks, then the IRD would be able to find the lost transport stream again by testing the frequencies given in the NIT 'other' subtables.

If the lost transport stream is not transmitted in the entered network, the **last possibility is to** check the `service_list_descriptor` of each transport stream to find the `service_id` of the previously selected service and use that transport stream. Note that this method can only be deployed if the neighbouring networks are using unique, coordinated `service_id` values.

The actual number of frequencies to be tested strongly depends on the network layout. If a network tries to reuse same frequencies for a transport stream in as many cells as possible, then the actual number of frequencies to be tested will be less than the number of cells. If all neighbouring networks that provide the same transport stream use coordinated frequencies, then again the number of different frequencies can be less than the number of neighbouring networks.

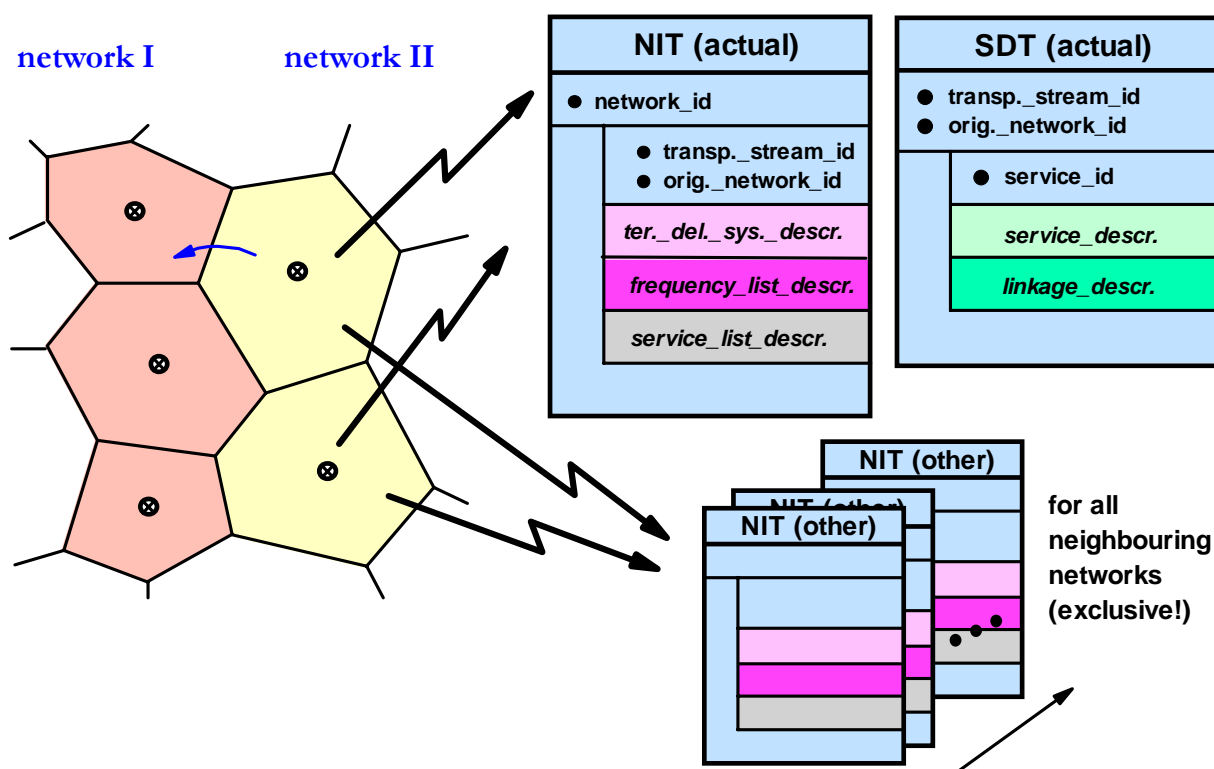

Figure 7: Hand-over at network borders by means of the frequency_list_descriptor and the service_list_descriptor

4.5.4.3 The occurrence of tuning failures

The hand-over method described above is, **except for a full frequency scan**, the simplest method that can be implemented on the basis of SI elements introduced for the stationary and portable reception of DVB-T, i.e. the terrestrial_delivery_system_descriptor and the frequency_list_descriptor in conjunction with the service_list_descriptor. The disadvantage of this solution is that tuning failures may occur that lead to a visible or audible service interruption. The occurrence of tuning failures shall be explained by means of figure 8.

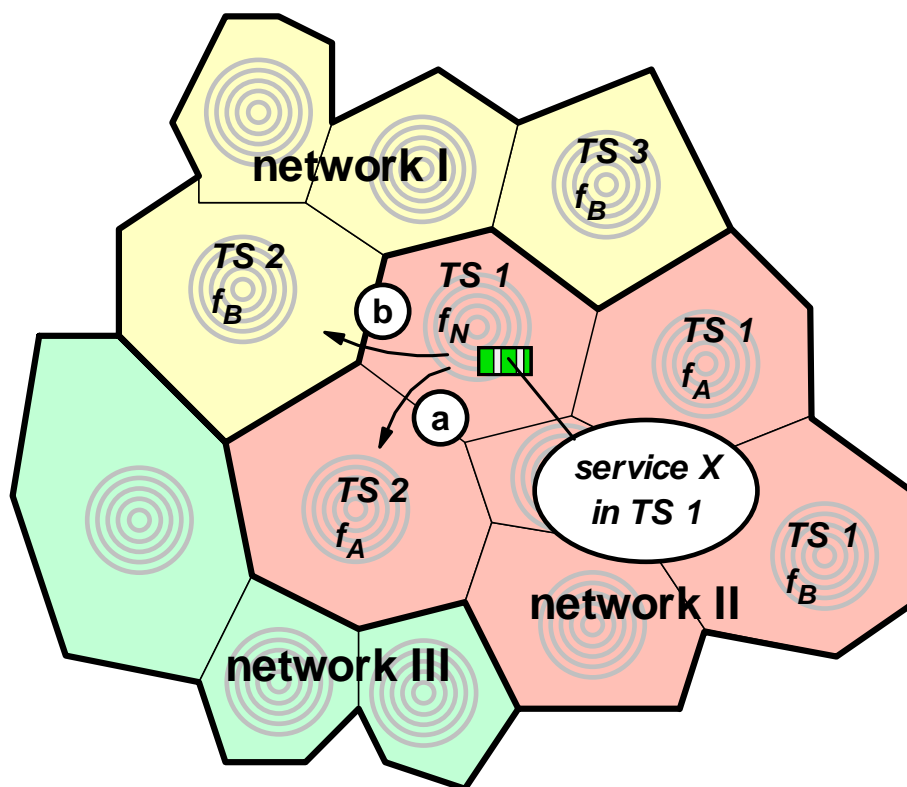

Figure 8: The occurrence of tuning failures

In network II the selected service (service X) is part of transport stream TS 1. At the current position of the receiver this transport stream is transmitted on frequency f_N . Reaching a cell border the receiver will check the alternative frequencies given in the NIT 'actual' and 'other' sub-tables. In the NIT 'actual' of network II the frequencies f_A and f_B are listed as alternative frequencies for transport stream TS 1.

If the receiver moved to another cell of the same network (case a), the test on frequency f_A would lead to a sufficient signal strength and the receiver starts to decode transport stream TS 2. Only after decoding TS2 the receiver can detect this tuning failure and switch to the next alternative frequency.

If the receiver moved to a cell of network I (case b), the frequency f_A will not carry a signal but testing f_B again leads to sufficient signal strength and the receiver starts to wrongly decode transport stream TS 2 of network I.

The risk of tuning failures is proportional to the number of alternative frequencies that are used to transmit a single transport stream in the different cells of a network. Note that a tuning failure in this context is the event where a receiver has decoded a transport stream that is different (by means of the original-network-id and transport-stream-id) from the transport stream that the receiver intended to decode.

4.5.4.4 Hand-over methods with a reduced risk of tuning failures

The risk of tuning failures can be reduced if the number of alternative frequencies that need to be tested is minimized. Some different approaches are described below. Note that these mechanisms require unique service-id's across transport streams and networks if service hand-over between varying transport streams in co-ordinated networks shall be successful.

4.5.4.4.1 Local SI insertion

One possibility is to make each cell a separate network (each network **consists of** only one cell) described by individual Service Information. The transport streams of the actual cell are then described with the NIT 'actual' while all neighbouring cells are described by corresponding NIT 'other' sub-tables.

Hence, the frequency for a transport stream of the actual cell is given in the `terrestrial_delivery_system_descriptor` in the NIT "actual" and the alternative frequencies for the surrounding cells (networks) can be found in the `terrestrial_delivery_system_descriptor` of the corresponding transport stream in the NIT "other" sub-tables. The `frequency_list_descriptor` is not used.

In this way, the receiver only needs to check the frequencies of the same transport stream in the surrounding cells and, by the geographical network layout the number of surrounding cells is typically limited to six or less. Depending on the geographical conditions, the number of actually different frequencies can be even less than the number of surrounding cells. Thus, the probability of tuning failures can be minimized by appropriate network planning and frequency reuse.

4.5.4.4.2 Cell identification

In those cases where a local SI insertion is not possible the reduction of relevant alternative frequencies can be achieved if the receiver knows to which cell the current signal belongs, what the neighbouring cells are and which frequency is used in which cell.

The following components provide this information:

- The `cell_frequency_link_descriptor` is similar to the `frequency_list_descriptor` but it also identifies the cells and the subcells for which the frequencies are valid.
- The `cell_list_descriptor` describes the coverage area of all the cells that belong to a network.
- The third component, the cell identification, is transmitted in the TPS bits (EN 300 744 [8]).

Using the cell identifier in the process of transport stream recovery enables the receiver to determine which cell has been entered cell after the first frequency test and to reduce the number of frequencies to be tested to those valid for the entered cell.

4.5.4.4.3 Performance enhancement with GPS data

If the receiver knows its actual position, for example it might use position data from an additional GPS receiver, then it will be able to determine which cell will be entered before the actual network border has been reached. This calculation depends on the geographical dimensions of the actual and surrounding cells given with the `cell_list_descriptor`. Knowing the cell that will be entered, the frequency used in that cell can be determined beforehand by using the `cell_frequency_link_descriptor`. However, it might not always be possible to exactly determine the destination cell, for example if the position is at a juxtaposition of three cells. Nevertheless, the risk of tuning failures can be dramatically reduced, especially if leaving large SFN cells.

4.5.4.4.4 Two front-end solution

The risk of tuning failures can completely be eliminated by means of a second front-end, provided that:

- a) a second demultiplexer is available; or
- b) `cell_id`, `cell_list_descriptor` and `cell_frequency_link_descriptor` are supported.

Furthermore, only a two front-end solution offers the possibility to make the duration of a successful hand-over shorter.

4.5.4.5 Performance considerations

Figure 9 gives an overview of the hand-over mechanisms that have been described before. They are arranged according to the performance **with respect** to the risk of service interruption. The performance of all solutions can additionally be enhanced by means of a second front-end and a second demultiplexer.

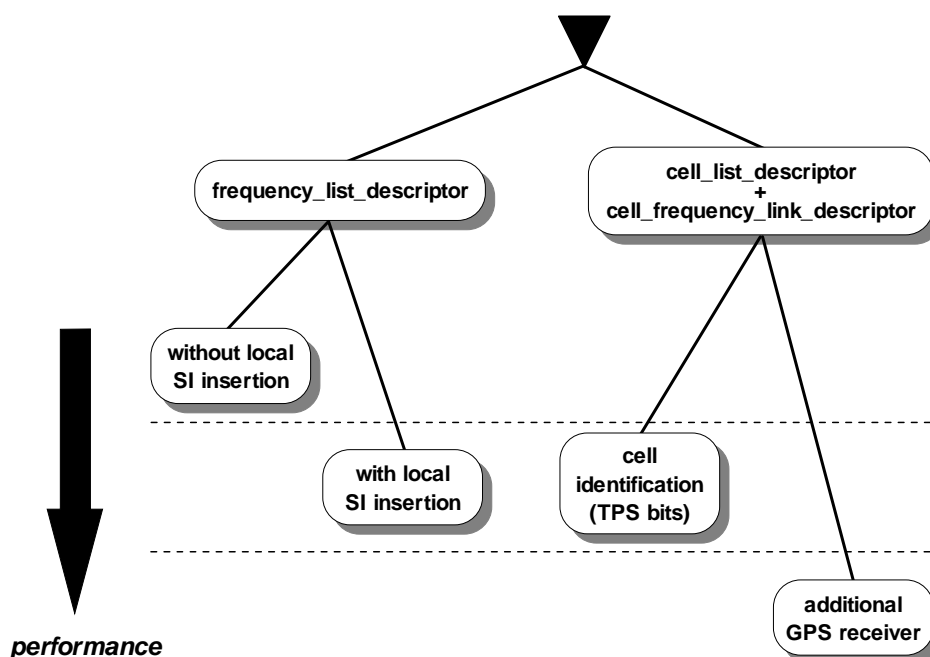

Figure 9: Performance analysis for the hand-over

4.5.4.6 Receiver guidelines

4.5.4.6.1 Hand-over by means of the frequency_list_descriptor

a) Prior knowledge:

- The user has selected a certain service. The service_id and the transport_stream_id of this actual service can be derived from the SDT.

b) Prior considerations:

- The receiver has to collect all alternative frequencies, that are:
 - firstly, the alternative frequencies used in the actual network. These frequencies can be found in the NIT actual, namely in the loop that describes the actual transport stream. Both the terrestrial delivery system descriptor and the frequency list descriptor have to be taken into account.
 - secondly, the alternative frequencies used in neighbouring networks (that may be only one frequency per network in the case of local SI insertion). These frequencies can be found in the NIT other if it is supported. The receiver has to check all networks given in the NIT other. If the actual transport stream also exists in the neighbouring network the alternative frequencies can be found in the same way as for the actual network. If the actual transport stream does not exist in the neighbouring network the receiver should search for the service id of the actual service, namely in the service list descriptor of all transport streams listed in the second loop of the NIT other. If the search has been successful, the frequencies of the corresponding transport stream are also valid alternatives.

c) If the signal strength decreases:

- The receiver has to find a new frequency, that means, it has to tune to the alternative frequencies one by one until a frequency with a sufficient signal strength has been found. The receiver has then to read the PAT and to check if the transport stream resp. the service of interest is available. If not (see clause 4.5.4.3 about tuning failures) other alternatives have to be checked. In order to speed up the test procedure different strategies can be implemented. They can, for example, be based on a likelihood estimated for each of the frequencies.

4.5.4.6.2 Hand-over by means of cell identification

- a) Prior knowledge:
- The user has selected a certain service. The `service_id` and the `transport_stream_id` of the actual service can be derived from the SDT. Furthermore, the receiver can determine the cell id by means of the TPS bits.
- b) Prior considerations:
- The receiver has to determine the neighbouring cells. For that purpose it has to compare the location of the actual cell with the location of other cells. Corresponding information is given in the cell list descriptor. The receiver should check both the cells of the actual network and - if the NIT other is available - the cells of neighbouring networks.
 - Thereafter, the receiver has to determine the frequencies that are used in the neighbouring cells. If a neighbouring cell is part of the actual network the receiver can directly read the `cell_frequency_link_descriptor` that is given for the actual transport stream in the NIT actual. If a neighbouring cell is part of another network the receiver has to check first whether the transport stream of interest is available in this network or not. In the first case the receiver can read the `cell_frequency_link_descriptor` that is given in the NIT other for the transport stream and the network actually considered. In the second case the receiver has to search for the same service in other transport streams (namely by means of the `service_list_descriptor` in the NIT other) and then - assuming that the search has been successful - to read the `cell_frequency_link_descriptor` of the transport stream that carries the service.
 - In all cases mentioned above, the receiver has to search within the `cell_frequency_link_descriptor` for those cell ids that have been identified as cell ids of neighbouring cells before. It can then read the frequency used in this cell as well as further frequencies that are used in subcells of this cell.
- c) If the signal strength decreases:
- The receiver has to find a new frequency, that means, it has to tune to the alternative frequencies one by one until a frequency with a sufficient signal strength is found. The receiver can then read the TPS data and check whether it contains the cell id of interest or not. If not (see clause 4.5.4.3 about tuning failures) other alternatives have to be checked. In order to speed up the test procedure different strategies can be implemented. They can, for example, be based on the likelihood estimated for each of the frequencies (see note).

NOTE: There is no need for a complete demodulation and decoding of the transport stream since tuning failures can be identified by means of TPS data. The PAT is not necessarily needed.

4.5.4.6.3 Hand-over by means of cell description and GPS position

- a) Prior knowledge:
- The user has selected a certain service. The `service_id` and the `transport_stream_id` of the actual service can be derived from the SDT. Furthermore, the receiver knows the frequency to which it is tuned and - by means of an additional GPS receiver - its position.
- b) Prior considerations:
- The GPS position, the `cell_list_descriptor`, the tuned frequency and the `cell_frequency_link_descriptor` can be used to determine the actual cell. Furthermore, the two first elements can be used to determine the cell the receiver will probably enter next. In some cases two or even three cells might come into question. The frequency of this(these) cell(s) and the frequencies used in the subcells of this(these) cell(s) can be determined as explained for the previous method.
- c) If the signal strength decreases:
- The receiver has to tune to the alternative frequencies one by one until a frequency with a sufficient signal strength is found. The receiver has then to read the `cell_id` - if supported in the TPS data - or the PAT in order to verify that the service of interest is available. If not (see clause 4.5.4.3 about tuning failures) other alternatives have to be checked.

4.5.4.6.4 Hand-over with two-front-end solutions

- a) Prior knowledge:
 - Identical to one of the scenarios mentioned above (depending on the actual solution).
- b) Prior considerations:
 - Identical to one of the scenarios mentioned above (depending on the actual solution).
- c) If the signal strength decreases:
 - While still presenting the service on the actual frequency the receiver might use the other front-end to tune to alternative frequencies in order to check the field strength of these frequencies. In this way the number of alternative frequencies can be reduced to the relevant ones in advance. Furthermore, tuning failures can be avoided if
 - a second demultiplexer is available, so that the receiver is able to read the PAT transmitted on the alternative frequency in parallel. Note, that the second demultiplexer can also be used to shorten the service interruption during the transition process from one frequency to another;
 - both the `cell_frequency_link_descriptor` and the cell identification by means of the TPS bits is supported (see note).

NOTE: A second demultiplexer is not necessary in this case.

4.5.4.7 Additional linkage modes

Most of the hand-over requirements can be fulfilled by means of the comparison methods that have been described so far. For some specific purposes of course an additional linkage mechanism is necessary which has not generally been introduced since it would have cause to much overhead.

The following three hand-over purposes are not covered by the comparison methods so that the `linkage_descriptor` provides a linkage type for mobile hand-over that is sub-divided into three different hand-over types:

- 1) Since the co-ordination of service identifiers has to be done within the context of an `original_network_id`, that means within one country, the service identifiers of a service that is offered in more than one country will probably differ from country to another. In order to support a hand-over even when crossing country boundaries the hand-over type "hand-over to an identical service in the neighbouring country" can be used.
- 2) If the neighbouring network does not provide exactly the same service but a local variation of the service, the service providers might have an interest that the receiver switches to this service instead of informing the user that the actual service is no longer supported. The hand-over type "hand-over to a local variation of the same service" can be used.
- 3) If the neighbouring network does not provide the actual service but there is an associated service available, the service providers of those services might have an interest that the receiver switches to this associated service instead of informing the user that the actual service is no longer supported. The hand-over type "hand-over to an associated service" can be used.

The hand-over linkage may occur both in the SDT and the NIT, since both the service providers and the network operators may have an interest of providing these hand-over facilities and since the SDT is usually under the control of the service provider whereas the NIT is under the control of the network operator.

4.5.4.8 Additional remarks

In order to support an optimum hand-over it is highly recommended that service providers uses only one `service_id` for one service even if DVB allows to allocate several `service_ids` for one service.

In distinction from the DAB system the DVB-T systems does not support the estimation of the position by the interpretation of signals from different transmitters or repeaters at well-known positions since the DVB-T systems does not allow the identification of a specific transmitter or repeater within a SFN.

4.6 Text string formatting

4.6.1 Use of control codes in names

Name fields are found in the descriptors shown in table 5.

Table 5: Name fields

bouquet_name_descriptor, multilingual_bouquet_name_descriptor	bouquet name
network_name_descriptor, multilingual_network_name_descriptor	network name
service_descriptor, multilingual_service_descriptor	service provider name service name
short_event_descriptor	event name

The following rules apply to the use of control codes in these name fields:

- a) It is expected that the range of name lengths transmitted might vary significantly. It is also expected that IRDs may have some limitations in the text length that can be displayed. Such limitations may depend on the method of display in use at the time. For example an IRD may be able to present the time-schedule of events in a graphical format, but only with a short label for each event.

The following mechanism allows a short section of a name to be identified. This uses the emphasis control codes with the following interpretation in the name fields:

- 0x86 short_name_on;
- 0x87 short_name_off.

These codes may only be used in pairs, and the short_name_off code should be preceded by the short_name_on code. Use of the codes to identify a short name in any name field is optional.

EXAMPLE: The [0x86]Asterix[0x87] Digital Satellite TV Network

(short name: Asterix).

The [0x86]P[0x87]ay [0x86]M[0x87]ovie [0x86]C[0x87]hannel

(short name: PMC).

- b) The use of the CR/LF code is not recommended in name fields.

4.6.2 Use of control codes in text

Text fields are found in the descriptors shown in table 6.

Table 6: Text fields

short_event_descriptor:	text
extended_event_descriptor:	item description
component_descriptor, multi-lingual_component_descriptor	component description
data_broadcast_descriptor	description of data broadcast service

The following rules apply to the use of control codes in these text fields:

- a) the "emphasis character on code" indicates that the IRD is recommended to emphasize the display of text which follows this code, e.g. by using bold or highlighted characters, and the "emphasis character off code" indicates when an IRD should revert to the normal character display;

EXAMPLE: The winners are announced of the [0x86]£10million[0x87] draw.
 Is J.R. [0x86]really[0x87] dead ?

- b) the CR/LF code is used to indicate points in the text where the IRD is recommended to start on a new line, i.e. it indicates new paragraphs. The IRD is expected to perform automatic word-wrapping to suit its text display width;
- c) the use of the Soft-HYphen code (SHY in the character coding tables) is recommended to indicate possible hyphenation points in long words.

5 Applications

The SI syntax is designed to work under a wide range of operation conditions. This clause describes some applications and explains how SI can be used in such an environment.

5.1 NVOD services

The MPEG-2 specification provides the means of transmitting several video programmes simultaneously in a single TS, which allows for the possibility of a broadcaster to provide a Near Video On Demand (NVOD) service.

This clause describes how such a service could be implemented and how it is described within the Service Information (SI).

The concept of providing a NVOD service where several time shifted versions of the same programme are transmitted simultaneously is not a new one, but it was not until the advent of the DVB System that the system became a viable one. Figure 10 shows the concept using six time-shifted versions of a service.

This is the simplest form of such a service where all the programmes are identical on all of the channels (other forms could exist where for example the interstitial breaks could be different).

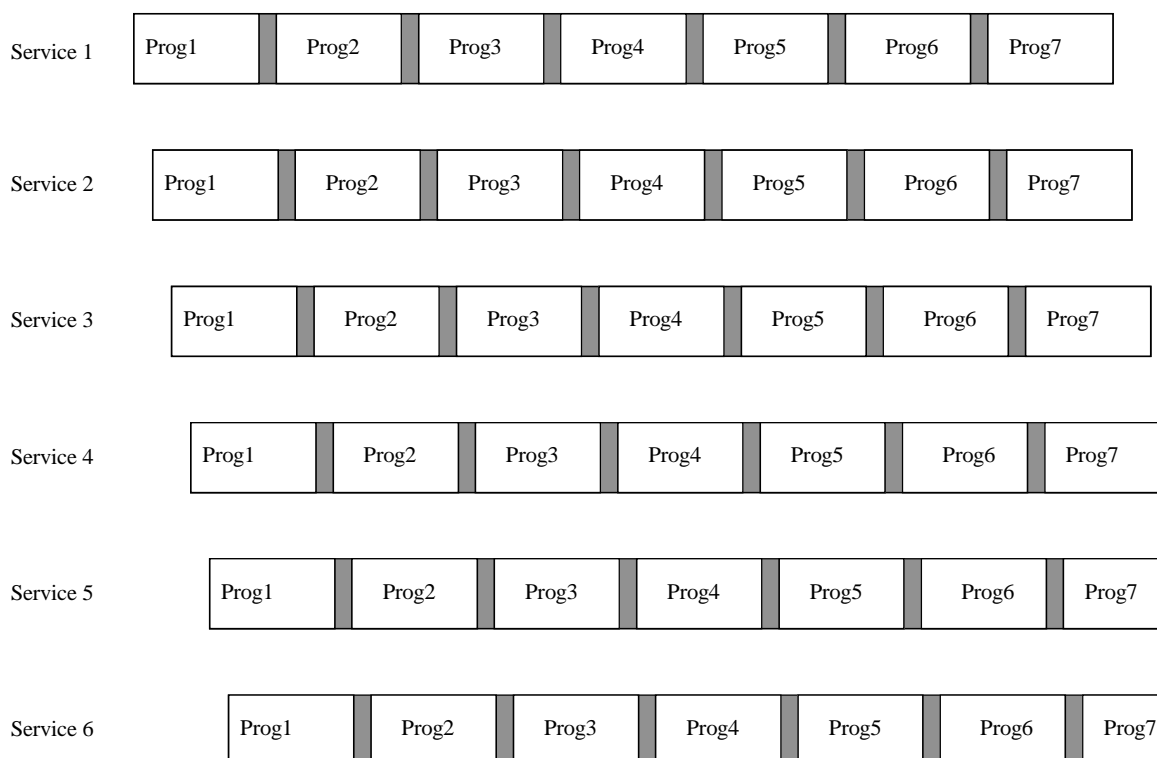

Figure 10: Example of a NVOD service

To describe such a NVOD service with conventional SI would require the repetition of six Event Information Tables (EIT). Instead the concept of a reference service is used.

The reference service is a fictitious service and provides a means within the SI of associating the actual time shifted services (services 1 to 6).

This reference service is allocated a `reference_service_id` which links a common description of the events within the service for all the services belonging to the NVOD service. The EIT of the reference service can always be found in the TS in which the NVOD services are located. Each time shifted service is given a full reference in terms of `transport_stream_id`, `original_network_id`, `service_id` and these services are listed in the `NVOD_reference_descriptor`. In addition, each time shifted service is described by a `time_shifted_service_descriptor` which points back to the reference description. This is shown in figure 11.

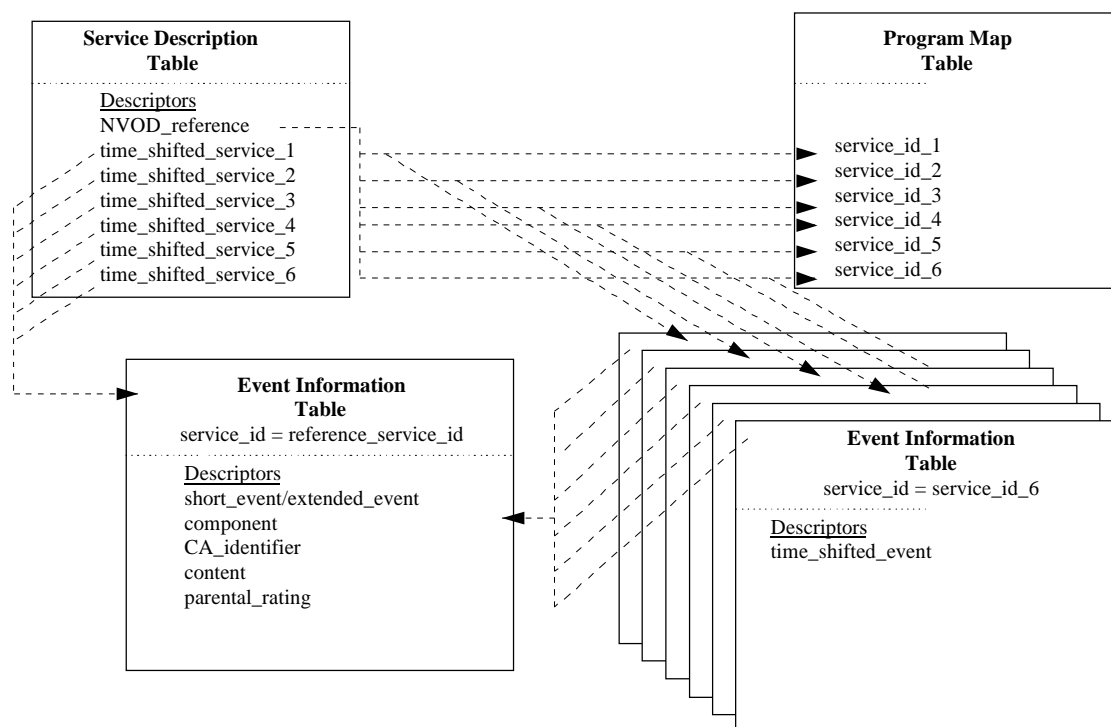

Figure 11: SI description of NVOD services

Using this method reduces the amount of data by nearly five times. The start times in the EIT for the reference service are set to void values of all "1"s, the correct start times for each event being given in the EITs of the respective time shifted services. All the events of the NVOD reference service (i.e. all the events which are referenced from the associated EIT present/following and EIT schedule tables of the associated time-shifted services) shall be described in the EIT present/following table of the NVOD reference service.

5.2 Mosaic services

5.2.1 General considerations

Mosaic services can be spread out over several TSs. A complete mosaic system can be organized in a tree structure.

A mosaic component is a collection of different video images to form a coded MPEG-2 video stream. The merging of the video images is performed at the source level, in such a way that at the display each image will occupy a specific area of the screen.

Each specific area is called a logical cell. Logical cells are composed of elementary cell(s). The mosaic screen is subdivided by a maximum of 8×8 elementary cells. Each elementary cell is numbered. A logical cell is a collection of elementary cells. Each logical cell is identified by a unique logical_cell_id.

The mosaic descriptor identifies the elementary cells (see figure 12), groups different elementary cells to form logical cells (see figure 13), and establishes a link between the content of all or part of the logical cell and the corresponding information carried in the SDT or EIT or BAT. Thus there is a close association between the mosaic descriptor and other SI Tables. The mosaic descriptor may be placed in either or both of the SDT and PMT sections for the mosaic service. Use in the SDT reduces the amount of interaction between the DVB SI and MPEG Tables. However, a single mosaic service containing multiple video components can only be described by having the mosaic descriptor appearing multiple times within the PMT section. Some logical cells may have no link to SI (see figure 12).

5.2.2 Relationship between mosaic service and SI/PSI Tables

Algorithm to look for a mosaic service:

- a) check the SDT Tables (actual TS / other TSs);
- b) if a mosaic service exists:
 - go to the corresponding TS;
 - process the PAT and PMT;
 - display the mosaic service;
 - look after the content of the mosaic service:
 - if you are interested by the content of one logical cell and if it is related to:
 - a bouquet: display the information of the corresponding BAT, go forward or cancel;
 - a service: display the information of the corresponding SDT, process the PAT and the PMT and display the selected service;
 - an event: display the information of the corresponding EIT, process the PAT and the PMT and display the selected event;
 - a mosaic service: display the information of the corresponding SDT, process the PAT, the PMT, display the selected mosaic service, and go to "- look after the content of the mosaic service".

0	1	2	3
4	5	6	7
8	9	10	11
12	13	14	15

Figure 12: Elementary cell organization

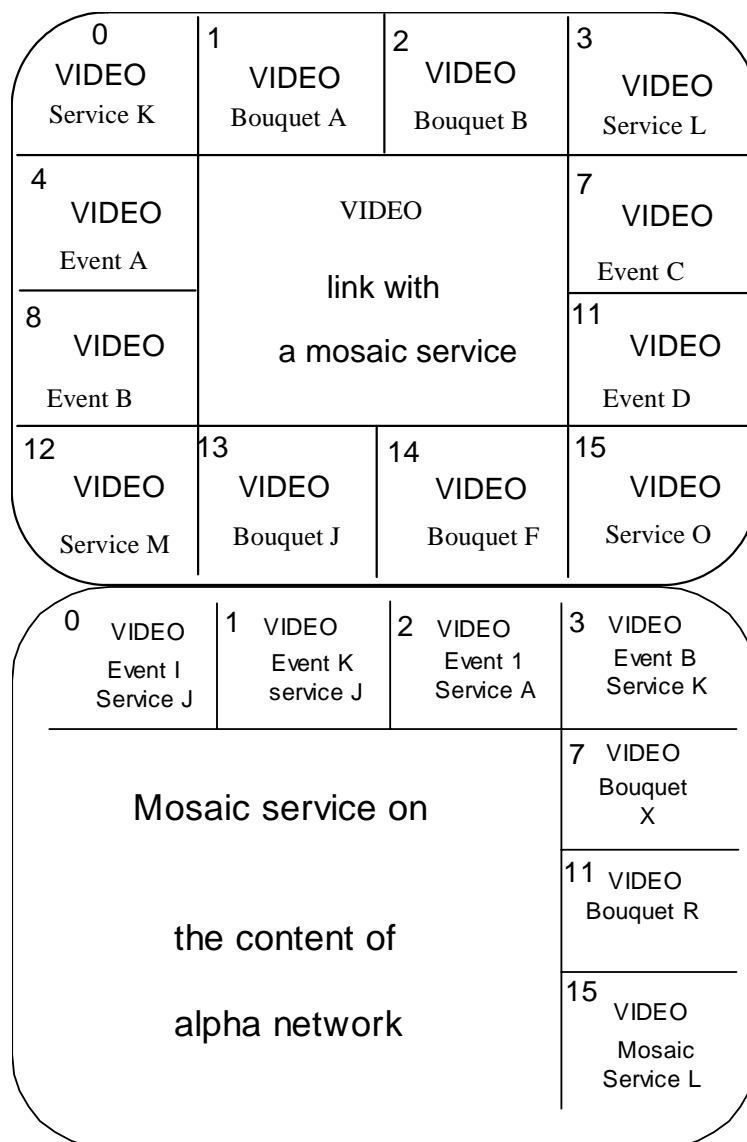

Figure 13: Examples of logical cell organization and content

5.3 Transitions at broadcast delivery media boundaries

A very common broadcast delivery media infrastructure will be, that signals received from the a satellite are converted and rebroadcast on a cable network. Depending on the size of the network, various technical options exist to facilitate these transitions.

5.3.1 Seamless transitions

A simple and low-cost solution is to remove the Quadrature Phase Shift Keying (QPSK) modulation from a satellite signal and replace it with a Quadrature Amplitude Modulation (QAM) suitable for the cable system or a modulation system suitable for (Satellite) Master Access TeleVision ((S)MATV). This mode is usually called a seamless transition. The major complication in this seamless mode is that the bit stream is left unchanged, which causes the NIT to be invalid for the actual delivery system to which the IRD is connected, for example a cable or SMATV system.

Seamless transitions are supported by the SI System, with the proviso that it must be readily possible for the IRD to identify whether the NIT information is valid. The rules of operation specified in clause 4.1.1 permit invalid NIT data in the case that applicable delivery system descriptors are not given for the actual delivery system.

The NIT is intended to simplify the set-up and installation procedure for the viewers, and to signal changes of tuning information. However, since it is impossible after a seamless transition of a broadcast delivery media boundary always to maintain valid information in the NIT, the IRD may require mechanisms in addition to reception of the NIT to obtain tuning data.

The support of seamless network transitions is based on the definition of a unique identification mechanism for a TS. The `transport_stream_id` field, as specified in the MPEG-2 standard, allows 65 536 TSs to be uniquely identified. If `transport_stream_id` values are uniquely assigned to multiplex originators in Europe, this number is considered too small. Thus, the range of unique identifications of TSs has been extended in the DVB SI by a field called `original_network_id` of 16 bits. The concatenation of these 2 fields results in 4 294 967 296 unique identifiers for TSs. This gives sufficient room to allow for a unique identification of TSs without requiring a registration procedure.

Given this unique identification of the TSs, it is then possible to build IRDs that do not require a correct NIT for correct installation purposes. In order to support seamless transitions of TSs for small cable systems and SMATV it is highly recommended that IRDs are able to initiate a frequency scan and store the unique TS identifiers with the sets of delivery system parameters. With this procedure the same information as carried in the NIT can be obtained. However, the presence of a NIT does provide certain advantages for installation set-up and network management purposes.

In a seamless mode of operation, an IRD is able to detect the permitted instances of incorrect NIT data, even though no modifications to the bit stream have been made. In general, a network transition will occur between two different types of networks, e.g. from satellite to cable. In this case, the detection of an incorrect NIT is based on the value of the `descriptor_tag` in the NIT's `delivery_system_descriptor`.

If the transition is between networks of the same type, the NIT should be replaced (see clause 5.3.2) by either a valid NIT or a NIT for another type of network. After the detection of an incorrect NIT, the IRD should be able to initialize itself correctly, e.g. by using a frequency scanning procedure.

5.3.2 Non-seamless transitions without re-multiplexing

A slightly more complex option is to restore the TS packet bit stream and to perform some selective TS packet replacements in the TS. Such a packet replacement option does not require a re-timestamp operation and is of relatively low complexity. Some error handling operations need to be implemented in order to deal with the unrecoverable errors in the satellite signal and with lost TS packets. The NIT is carried in TS packets with a unique Packet Identifier (PID) value which allow the replacement function to be based on simple PID filter logic.

If a network transition is based on a TS packet replacement function, it is desirable that the new NIT information is stored and managed at the network boundary. This is the logical location, as each network operator will demand the control over the frequency allocation in his network. For this local control to be as simple as possible, a fixed PID value is selected for TS packets carrying NIT data. A certain minimum data rate for the transmission of NIT data is specified to allow the replacement function to meet the minimum repetition time for the replacement NIT.

5.3.3 Transitions with re-multiplexing

The most complicated and expensive solution is to combine two or more TSs into a single one at the broadcast delivery media boundary. This re-multiplexing also involves the re-timing of the TS packets and the generation of a new SI data stream. The SI data in other TSs might in this case also be incorrect, which requires the checking and regeneration of the SI data in all TSs in the network. This option will only be feasible for very large networks.

5.4 Announcements

DVB supports spoken announcements of several types. They can dynamically occur during any event, If a certain service supports such announcements, the corresponding SDT shall indicate this by means of a `announcement_support_descriptor`. This descriptor gives information about which types of announcements may occur and where the announcements will occur. This can either be in the audio stream which is currently decoded or in other audio streams on the same or on a different transport stream.

The dynamic flags which trigger the real time announcement switching are encoded in the private data bytes of the adaptation field. The syntax of the `announcement_switching_data_field` is defined in EN 300 743 [15]. This data field is present only in those streams that carry announcements. Services that support announcements by means of giving a reference to announcement streams will not provide this `announcement_switching_data_field` in their streams. Thus, the demultiplexer has to monitor the adaptation field of the announcement stream if the support of announcements is realized by referencing an announcement stream. If a reference is made to an announcement stream in a different TS a copy of the announcement switching data field has to be embedded in the actual TS, namely in the audio stream of a service that uses the reference to an announcement stream in a different TS. The service and the stream that carries this duplicated trigger information is also indicated by the `announcement_support_descriptor` of the SDT.

6 Storage media

A partial bitstream from the DVB TS does not carry any DVB SI data other than the Selection Information Table (SIT) described in EN 300 468 [1]. The SIT contains a summary of all SI information in the broadcast stream relevant for storage media. All relevant MPEG-2 PSI information should be coded to correctly describe the partial MPEG-2 TS.

The presence of the SIT in a bitstream flags the bitstream as a partial bitstream coming from the digital interface. This allows the IRD to ignore the absence of any mandatory SI tables and only use information coded into the SIT.

In addition to the SIT table, a second table, called Discontinuity Information Table (DIT), is defined in EN 300 468 [1]. This table is to be inserted at transition points at which SI/PSI information may be discontinuous. The IRD may use this information to recapture the SI/PSI information. Note that it is not necessary to signal normal changes to the SI/PSI information, for example an event transition, which are covered by the table version signalling mechanism.

6.1 Program Association Table (PAT)

The PAT only lists selected services. In addition, the `network_PID` reference should take the value of the `SIT_PID` instead of the `NIT_PID`. The references to non-selected programs/services should be removed. The PAT should not violate the MPEG-2 Systems rules.

6.2 Program Map Table (PMT)

The PMT should not violate the MPEG-2 Systems requirements.

For selected services, the corresponding PMT section may remain unchanged only if all elementary streams referenced from it are selected and kept unchanged. In case any of the referenced elementary streams of the service is removed or changed, the PMT section should be modified to reflect this.

For non selected services the obsolete PMT sections may remain in the stream only if they are in the same PID as a PMT section of any selected service. In all other cases they should be removed.

6.3 SI tables (NIT, SDT, EIT, BAT, RST, TDT, TOT)

These tables should be removed after selection.

6.4 Selection Information Table (SIT)

The SIT should be packetized in TS packets starting from the beginning of the payload, i.e. in a packet with `payload_unit_start_indicator` in the TS packet header set to "1" and with the `pointer_field` set to "0x00". Furthermore, it is recommended that the SIT is packetized in a single TS packet (if possible).

The `transmission_info_loop` in SIT should contain the `partial_transport_stream_descriptor`.

The following loop should contain all the `service_ids` of the selected services. The `service_loop` may contain descriptors from the original EIT and SDT.

6.5 Discontinuity Information Table (DIT)

At a transition, the bitstream may be discontinuous with respect to any of the SI information (including PAT and PMT). The DIT table shall be inserted at this transition point.

Whenever a partial bitstream discontinuity occurs, two transport packets belonging to PID 0x001E shall be inserted directly at the transition point, with no other packets in between. The first one shall have 184 bytes of adaptation field stuffing with `discontinuity_flag` set to "1" (in order to ensure compliance to MPEG-2 continuity counting constraints for successions of transitions introduced at independent transmission/storage stages). The second of these transport packets shall contain the "DIT" and shall not have such a flag set to "1".

Annex A: Bibliography

- Implementation guidelines for use of telecommunications interfaces in the Digital Broadcasting systems (DVB Project office).
- "System Information for Digital Television", ATSC Document A/56 (<http://www.atsc.org>).

History

Document history		
Edition 1	April 1996	Publication as ETR 211
Edition 2	August 1997	Publication as ETR 211
V1.4.1	July 2000	Publication
V1.5.1	January 2003	Publication
V1.6.1	May 2004	Publication